

# SBM-40 LEDs

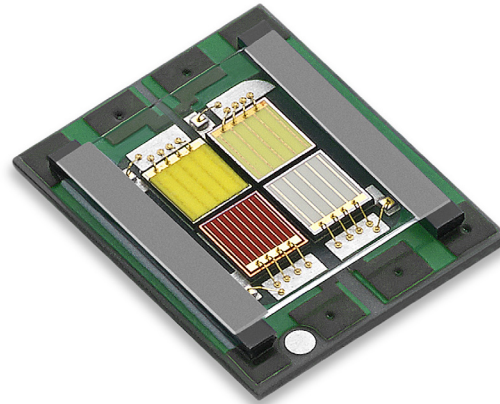

## Table of Contents

Technology Overview .....2

Binning Structure .....3-4

Ordering Part Number .....5

Product Shipping & Labeling Information.....6

Optical & Electrical Characteristics ..... 7-15

Thermal Resistance ..... 16

Mechanical Dimensions .. 17

Solder Profile ..... 18

Packaging Specification .. 19

Revision History..... 20

## Features:

- Extremely high optical output at 2A:
  - up to 300 Red lumens
  - up to 400 Green lumens
  - up to 1.8 Blue Watts
  - up to 400 White lumens
- High thermal conductivity package
- Four chips with emitting area of 1 mm<sup>2</sup> each
- Environmentally friendly: RoHS compliant
- Variable drive currents: 0.2A to 2A
- Available in RGBW combination

## Applications:

- Entertainment /Stage Lighting
- Architectural Lighting
- Spot Lighting
- Pool and Fountain Lighting
- Medical Lighting
- Fiber-coupled Illumination
- Machine Vision

## Technology Overview

Luminus LEDs™ benefit from a suite of innovations in the fields of chip technology, packaging and thermal management. These breakthroughs allow illumination engineers and designers to achieve solutions that are high brightness and high efficiency.

### Packaging Technology

Thermal management is critical in high power LED applications. With a thermal resistance from junction to case of 0.6° C/W (electrical), Luminus SBM-40 LEDs have industry-leading thermal resistance. This allows the LED to be driven at higher current while maintaining a low junction temperature, thereby resulting in brighter solutions and longer lifetimes.

### Reliability

Designed from the ground up, Luminus LEDs are one of the most reliable light sources in the world today. Luminus LEDs have passed a rigorous suite of environmental and mechanical stress tests, including mechanical shock, vibration, temperature cycling and humidity, and have been fully qualified for use in extreme high power and high current applications. With very low failure rates and median lifetimes that typically exceed 60,000 hours, Luminus LEDs are ready for even the most demanding applications.

### Environmental Benefits

Luminus LEDs help reduce power consumption and the amount of hazardous waste entering the environment. All LED products manufactured by Luminus are RoHS compliant and free of hazardous materials, including lead and mercury.

## Understanding Luminus LED Test Specifications

Every Luminus LED is fully tested to ensure that it meets the high quality standards expected from Luminus' products.

### Testing Temperature

Luminus surface mount LEDs are typically tested with a 20 ms input pulse and a junction temperature of 25°C. Expected flux values in real world operation can be extrapolated based on the information contained within this product data sheet.

This method of measurement ensures that Luminus LEDs perform in the field just as they are specified.

### Multiple Operating Points

The tables on the following pages provide typical optical and electrical characteristics. Since the LEDs can be operated over a wide range of drive conditions (currents from 0.2 A to 2A, and duty cycle from <1% to 100%), multiple drive conditions are listed.

### SBM-40 Red, Green, Blue and White Binning Structure<sup>1,2</sup>

All SBM-40 LEDs are tested at 0.7A for luminous flux, radiometric flux and dominant wavelength and placed into one of the following wavelength and flux bins. The binning structure is universally applied across each color of the SBM-40 product line.

Color	Flux Bin	Min... Max Luminous Flux (lm) @ 0.7 A	Min...Max Radiometric Flux (mW) @ 0.7A
Red	BB	56 ... 71	
	CA	71 ... 90	
	CB	90 ... 112	
Green	DA	112 ... 140	
	DB	140 ... 180	
	FA	180 ... 224	
Blue	UA		630 ... 710
	UB		710 ... 800
	VA		800 ... 900
White	DB	140 ... 180	
	FA	180 ... 224	

### Red, Green and Blue Dominant Wavelength Bins

Color	Wavelength Bin (FF)	Minumum Wavelength (nm) @ 0.7A	Minumum Maximum (nm) @ 0.7A
Red	R	620	632
Green	G8	521	527
	G9	527	533
Blue	B8	449	453
	B9	453	457

Note 1: Luminus maintains a +/- 6% tolerance on flux measurements.

Note 2: Only specific bins are available for large order, contact Luminus sales team for more information.

**SBM-40 White Chromaticity Coordinates**

Chromaticity Coordinates		
Bin Code (WW)	CIEx	CIEy
1A	0.3190	0.3507
	0.3267	0.3370
	0.3107	0.3043
	0.3020	0.3178

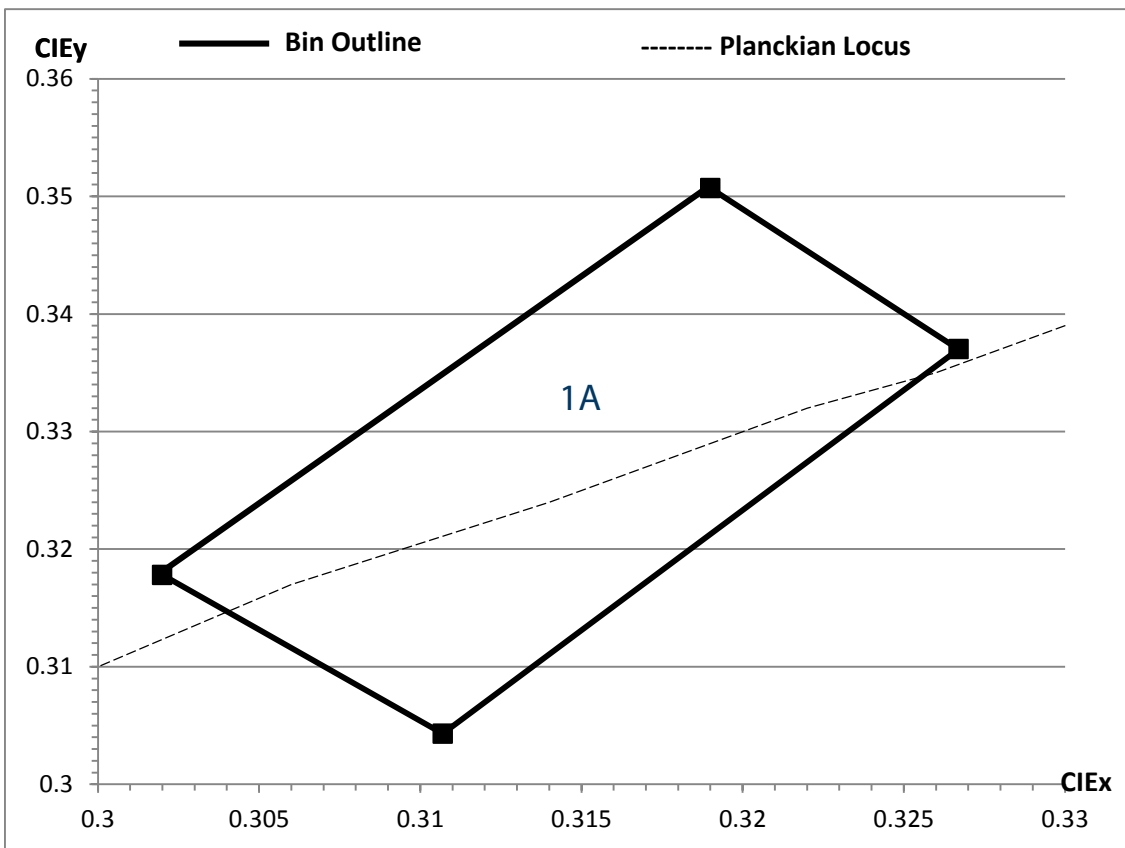

### Part Number Nomenclature

**SBM** — **40** — **RGBW** — **N41** — **<abnnn>**

Product Family	LED Emission Area	Color	Package Configuration	Bin kit
SBM: Multi-Chip Surface mount device, Non-Encapsulated	40: 4 dies - each 1.0 mm <sup>2</sup>	<Y>: Color R = Red G = Green B = Blue W = White	N41: 10.0 mm x 11.0 mm - Surface mount, shipped in tape & reel	Flux and Chromaticity bin kit code - See available ordering codes below

### SBM-40 Bin Kit Ordering Nomenclature and Ordering Part Number

All SBM-40 RGBW products are sold in sets of flux and chromaticity bins called bin kits. Each bin kit specifies a minimum flux bin and a specific selection of chromaticity bins. The ordering part number designation is as follows:

Bin Kit	Blue Wavelength bins		Green Wavelength bins		Flux bins	Ordering Part Number
	B8	B9	G8	G9		
QA100	✓	✓	✓	✓	Full Distribution	SBM-40-RGBW-N41- QA100

For other bin kits, please contact a Luminus representative.

#### Example:

The ordering part number SBM-40-RGBW-N41-QA100 refers to bin kit which consists of a RGBW, SBM-40 emitter, with Red Flux > 56 lm and Red DWL range of 620nm-632 nm; Green flux > 112 lm and Green DWL range of 521nm to 533 nm; Blue power > 630 mW and Blue DWL range of 449 nm to 457nm; White flux >140 lm and chromaticity values within the box defined by the four points (0.3190, 0.3507), (0.3267, 0.3370), (0.3107, 0.3043), (0.3020, 0.3178) measured at drive current =0.7A.

### Product Shipping & Labeling Information

All SBM-40 products are packaged and labeled with their respective bin as outlined in the tables on pages 3 & 4. When shipped, each reel will only contain one bin. The part number designation is as follows:

**SBM** — **40** — **RGBW** — **N41** — **QA<XXX>**

Product Family	Chip Area	Color	Package Configuration	Bin Kit Identifier
Surface Mount (window)	4.0 mm <sup>2</sup>	R: Red G: Green B: Blue W: White	Internal Code	QA <b>XXX</b>

**Optical & Electrical Characteristics <sup>1,2</sup>**

Parameter	Symbol	Red	Green	Blue	White	Unit
Drive Condition <sup>3</sup>	I	0.7	0.7	0.7	0.7	A
Emitting Area	-	1.0	1.0	1.0	1.0	mm <sup>2</sup>
Emitting Area Dimensions	-	1.0 x 1.0	1.0 x 1.0	1.0 x 1.0	1.0 x 1.0	mm x mm
Dominant Wavelength	$\lambda_{d\ min}$	620	521	449	-	nm
	$\lambda_{d\ typ}$	625	527	453	-	nm
	$\lambda_{d\ max}$	632	533	457	-	nm
FWHM (typ.)	$\Delta\lambda_{1/2}$	17	32	21	N/A	nm
Chromaticity Coordinates <sup>4</sup> (typ.)	x				0.31	-
	y				0.32	-
Forward Voltage	$V_{F\ min}$	2.0	2.8	2.8	2.8	V
	$V_{F\ typ}$	2.5	3.8	3.4	3.4	V
	$V_{F\ max}$	3.0	5.0	4.0	4.0	V
Minimum Current <sup>5</sup>	-	0.1	0.1	0.1	0.1	A
Maximum Current <sup>5</sup>	-	2	2	2	2	A
Maximum Operating Junction Temperature <sup>5,6</sup>	$T_{j\ operating,max}$	100	140	130	130	°C
Absolute Maximum Junction Temperature <sup>5,6</sup>	$T_{j\ absolute\ max}$	125	170	170	170	°C
Storage Temperature Range	-	-40/+100	-40/+100	-40/+100	-40/+100	°C

**Optical & Electrical Characteristics <sup>1,2</sup>**

- Note 1: All ratings are based on test conditions of  $I_f = 700$  mA,  $T_c = 25^\circ\text{C}$ , 20 millisecond pulse.  $T_{\text{case}}$  is defined on Thermal Resistance section, page 16.
- Note 2: Unless otherwise noted, values listed are typical. Devices are production tested and specified at 0.7A/mm<sup>2</sup> for red, green, blue and white. Values provided at 2A based on characterization and measurements at 2A/mm<sup>2</sup>.
- Note 3: SBM-40 RGBW devices can be driven at currents ranging from 0.2 A to 2 A depending on color and at duty cycles ranging from 1% to 100%. Drive current and duty cycle should be adjusted as necessary to maintain the junction temperature desired to meet application lifetime requirements.
- Note 4: In CIE 1931 chromaticity diagram coordinates, normalized to  $x+y+z=1$ .
- Note 5: SBM-40 RGBW devices are designed for continuous operation to a maximum current as specified above. Product lifetime data is specified at recommended forward drive currents. Sustained operation at or beyond maximum currents will result in a reduction of device lifetime compared to recommended forward drive currents. Actual device lifetimes will also depend on junction temperature. Refer to the lifetime derating curves for further information.
- Note 6: Maximum Operating Junction Temperature and Absolute Maximum Junction Temperature assume that with all four (RGBW) LEDs operating simultaneously at 2A, a maximum case temperature ( $T_c$ ) of 69°C is not exceeded; with all four LEDs operating simultaneously at 1.75A, a maximum  $T_c$  of 73°C is not exceeded; and with all four LEDs operating simultaneously at 1.5A, a maximum  $T_c$  of 77°C is not exceeded. Please see Application Note APN-002561 for details.



## Optical & Electrical Characteristics<sup>7</sup>

### Relative Luminous Flux - Red

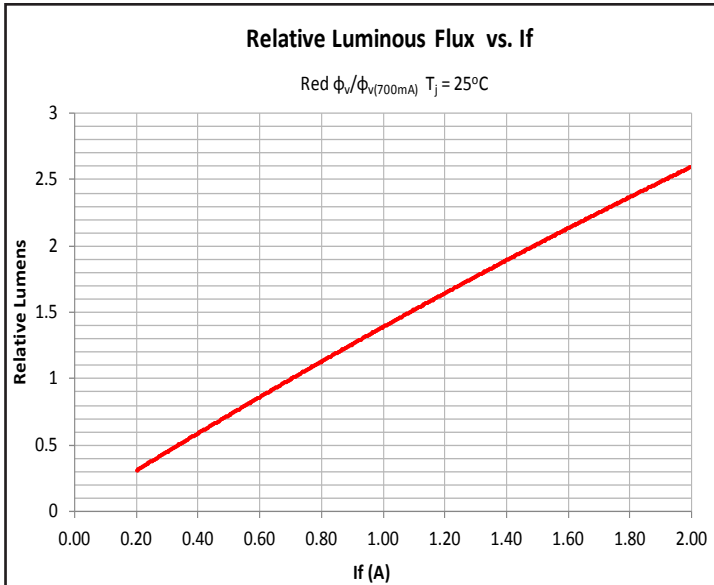

### Relative Luminous Flux - Green

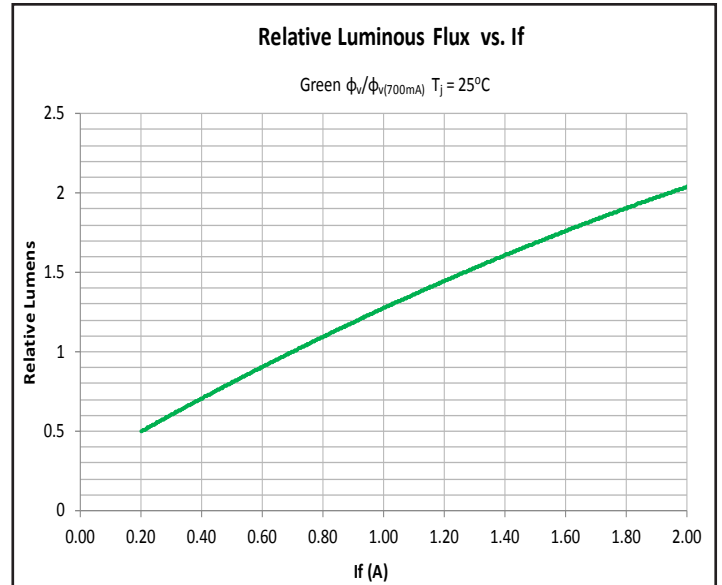

### Relative Radiant Power - Blue

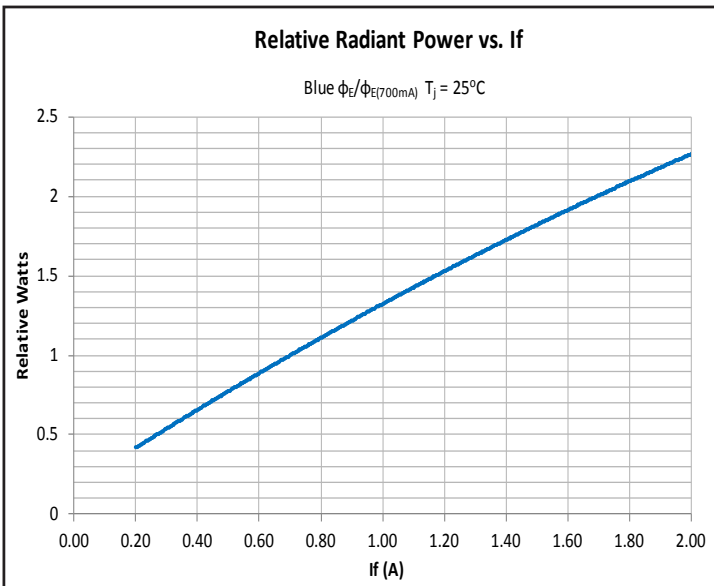

### Relative Luminous Flux - White

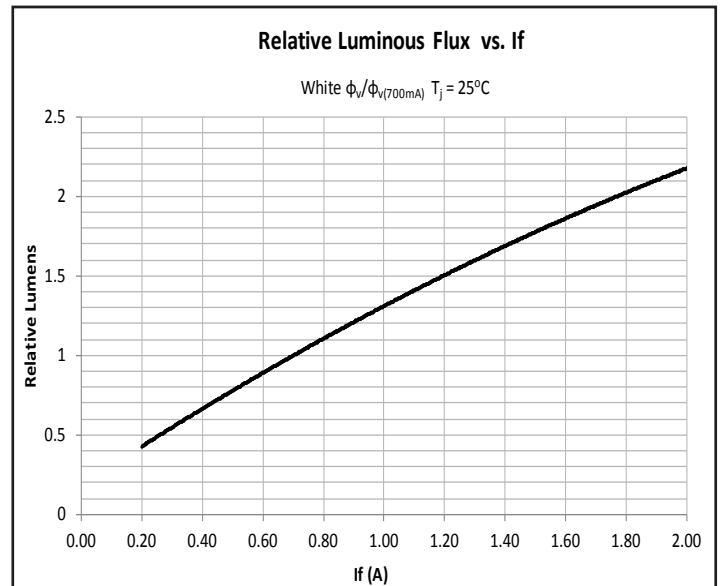

Note 7: Flux and power values are measured using a current pulse of typical 20 ms. Luminus maintains a test measurement accuracy for LED flux and power of  $\pm 6\%$ .

## Optical & Electrical Characteristics

Voltage as function of Forward Current - Red

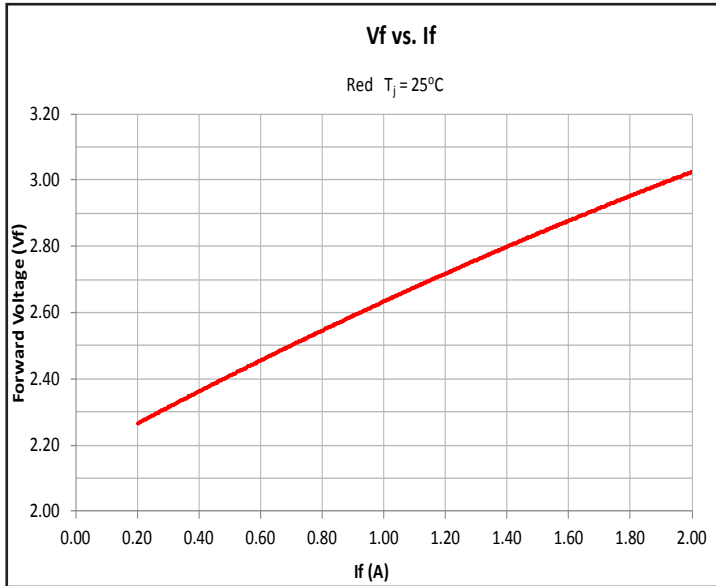

Voltage as function of Forward Current - Green

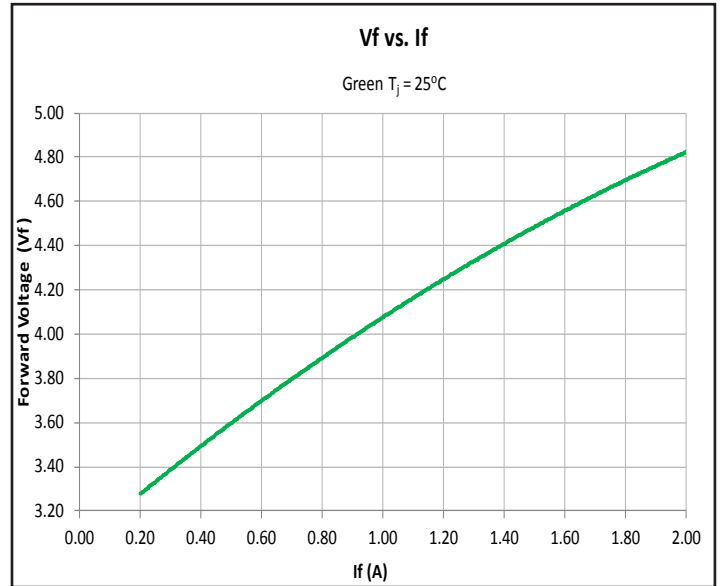

Voltage as function of Forward Current - Blue

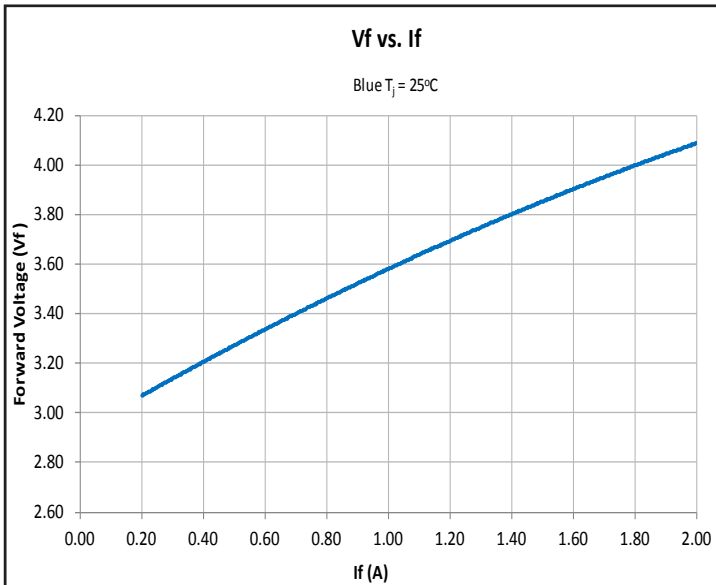

Voltage as function of Forward Current - White

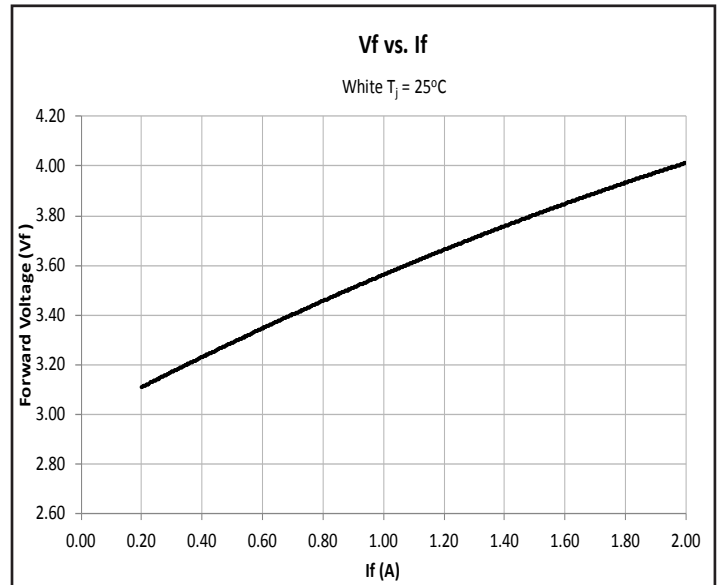

## Optical & Electrical Characteristics

**Wavelength change as function of Current - Red**

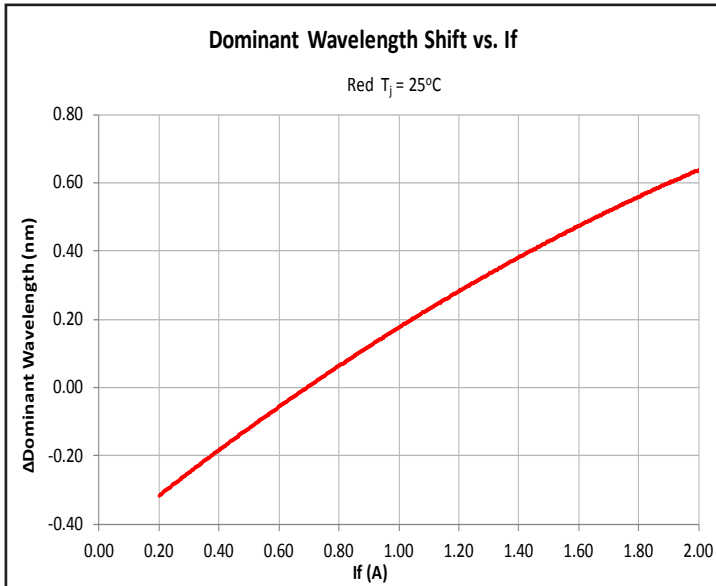

**Wavelength change as function of Current - Green**

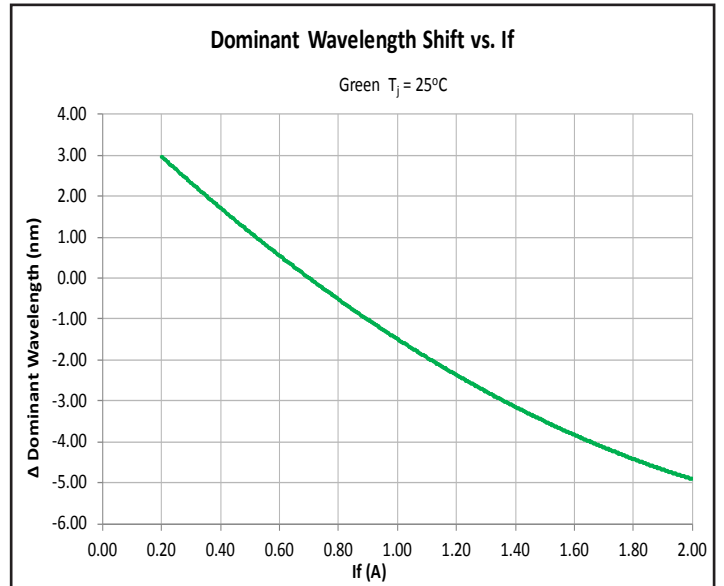

**Wavelength change as function of Current - Blue**

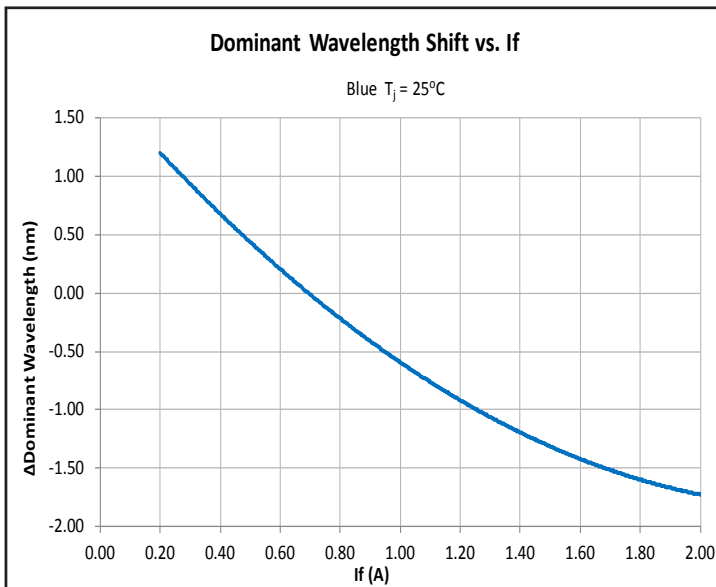

**CIEx, y change as function of Current - White**

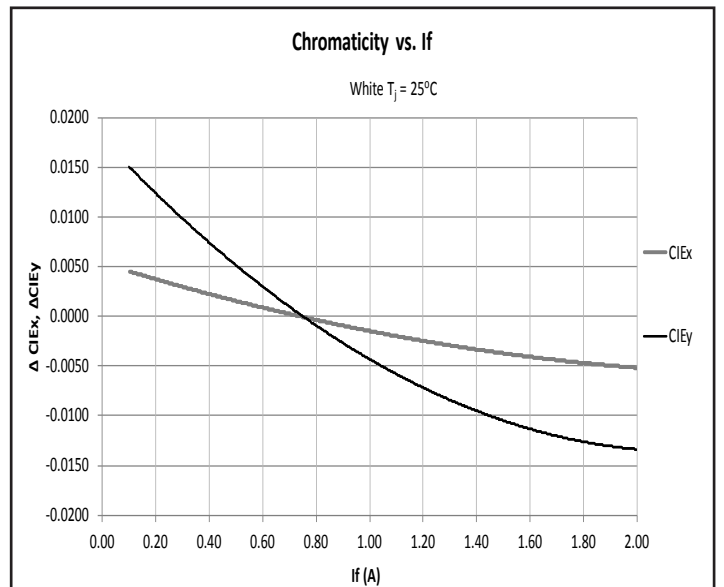

## Optical & Electrical Characteristics vs. Temperature

### Relative Luminous Flux vs. Temperature - Red

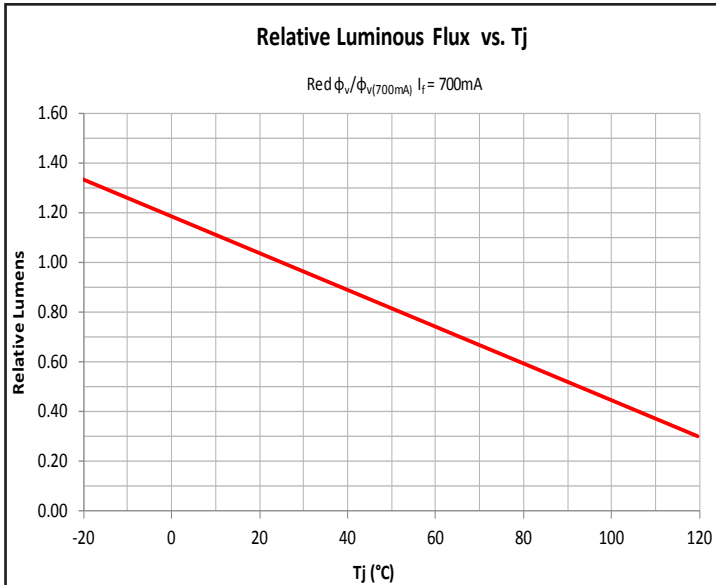

### Relative Luminous Flux vs. Temperature - Green

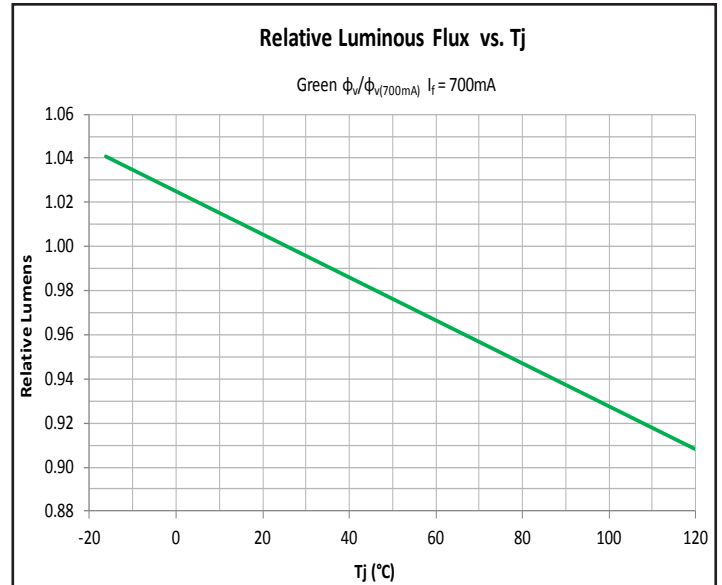

### Relative Radiant Power vs. Temperature - Blue

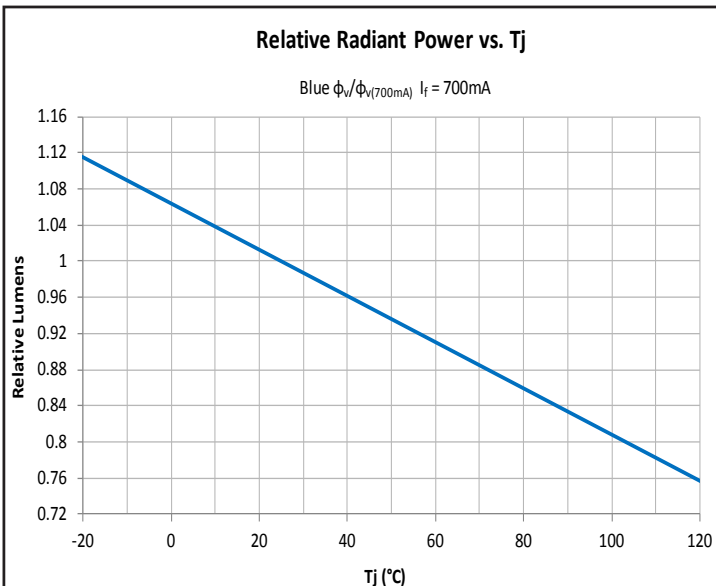

### Relative Luminous Flux vs. Temperature - White

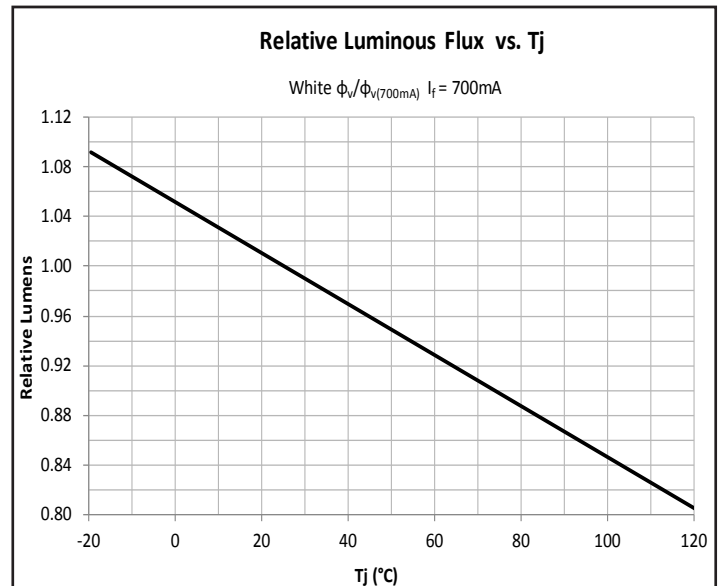

## Optical & Electrical Characteristics vs. Temperature

### Relative Forward Voltage vs. Temperature - Red

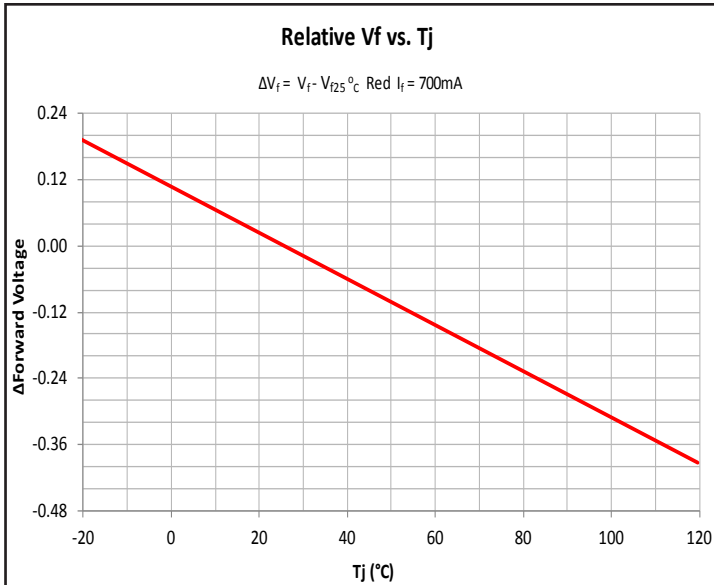

### Relative Forward Voltage vs. Temperature - Green

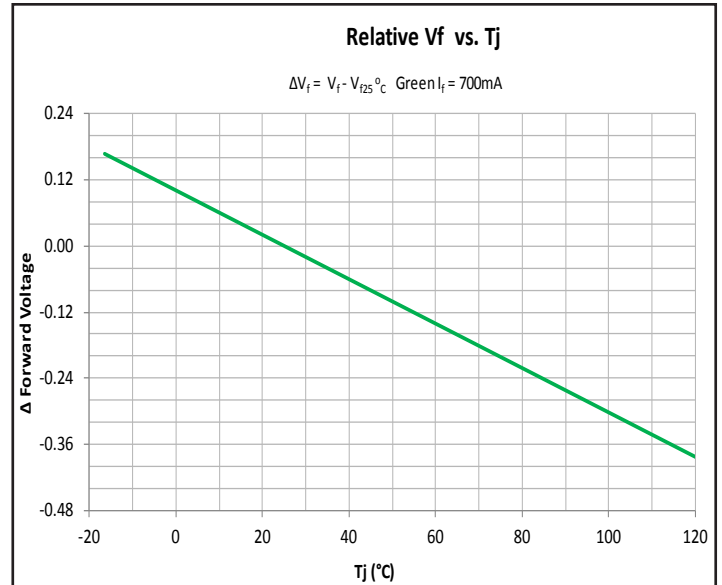

### Relative Forward Voltage vs. Temperature - Blue

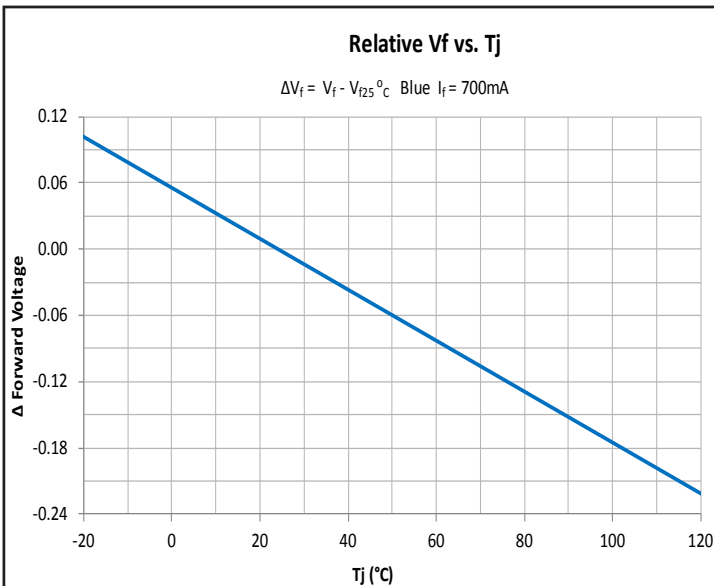

### Relative Forward Voltage vs. Temperature - White

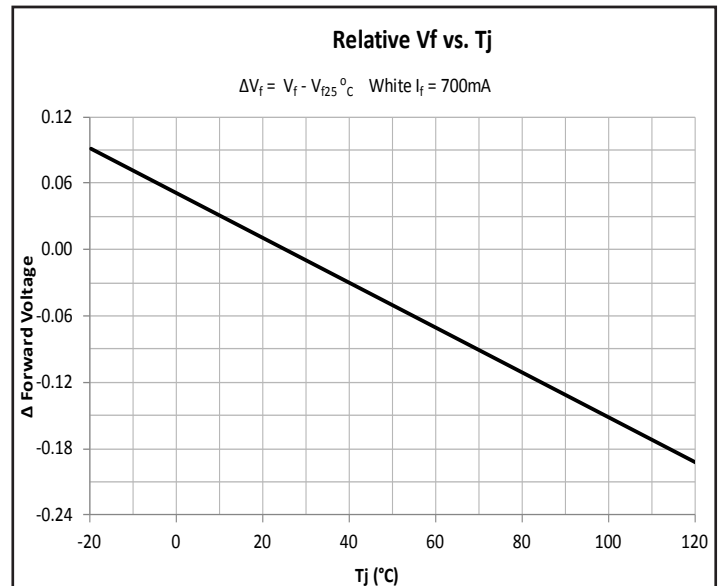

## Optical & Electrical Characteristics vs. Temperature

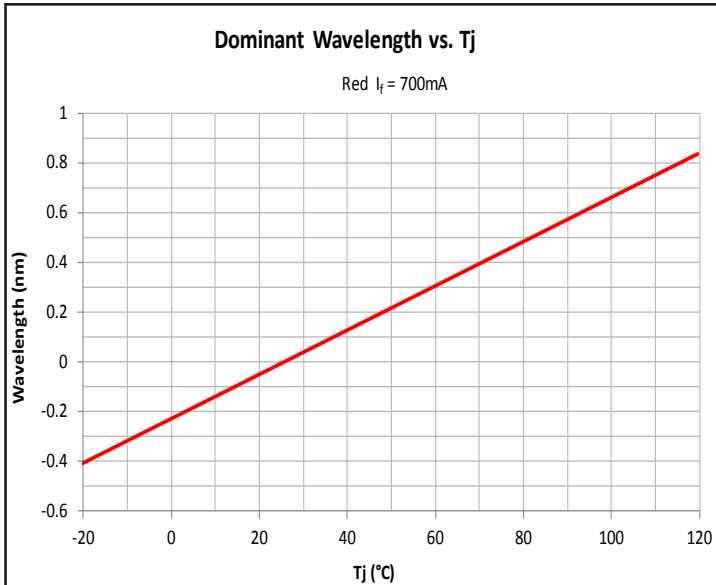
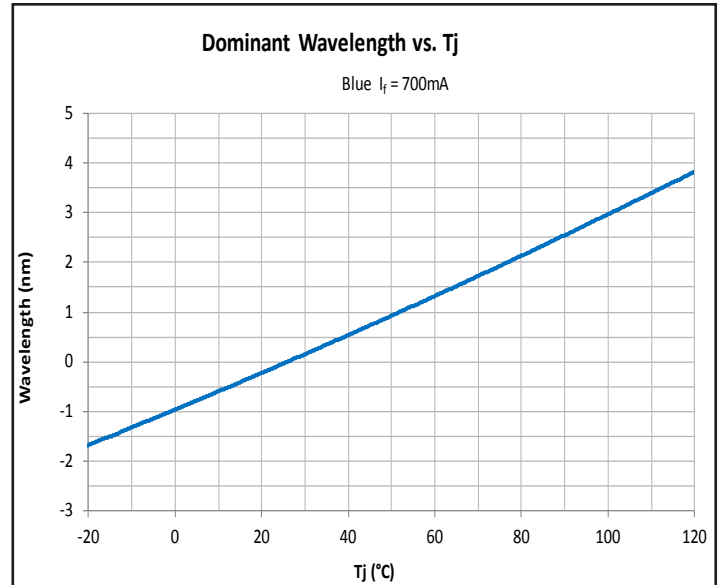
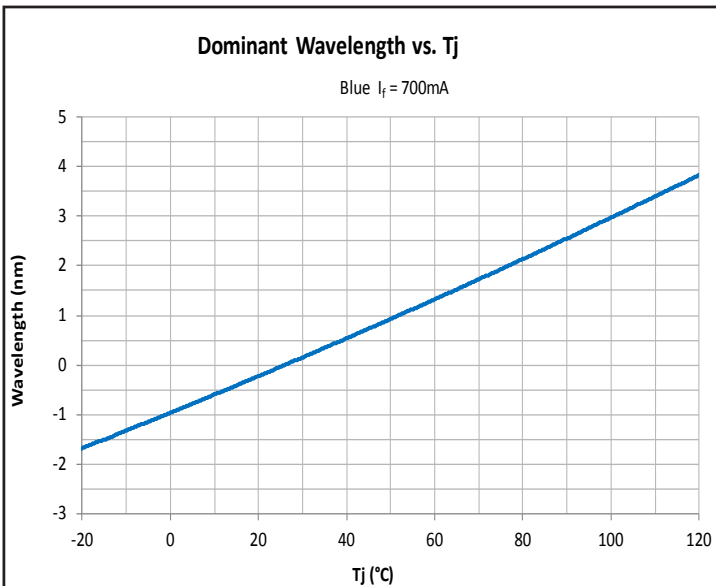
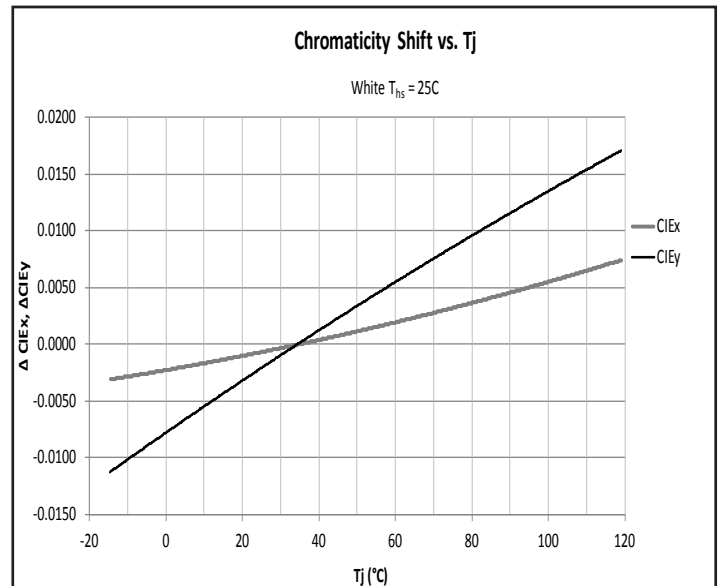
**Relative Dominant Wavelength vs. Temperature - Red**

**Relative Dominant Wavelength vs. Temperature - Green**

**Relative Dominant Wavelength vs. Temperature - Blue**

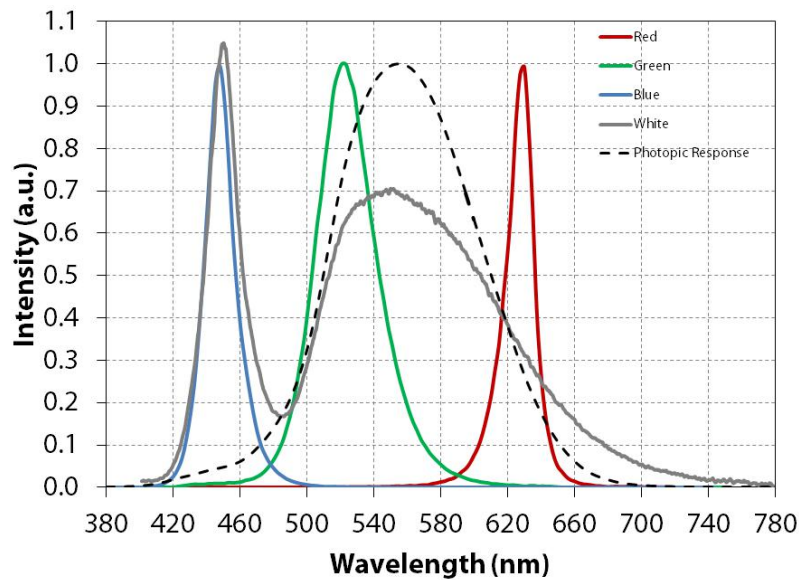
**CIEx, y change vs. Temperature - White**

## Optical & Electrical Characteristics

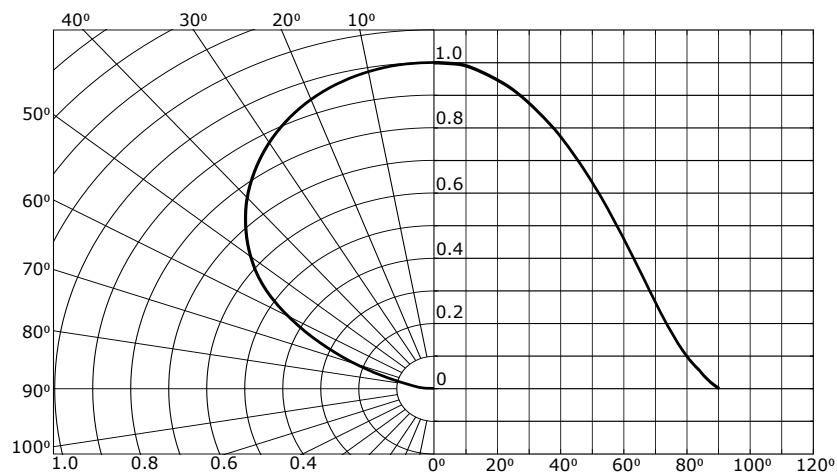
**SBM-40-RGBW Spectrum<sup>8</sup>**



**SBM-40-RGBW Angular Distribution**



Note 8: Typical spectrum from Red, Green, Blue and White LEDs at reference current of 0.7 A, CW. Please contact Luminus to obtain data in excel format.

### Thermal Resistance

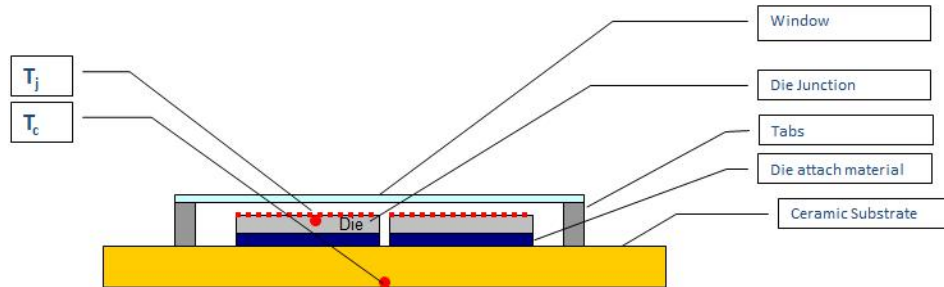

Thermal resistance junction to case,  $R_{th(j-c)_{real}} = 0.7 \text{ } ^\circ\text{C/W}$  (typ.), (All chips operated simultaneously)  
 Thermal resistance junction to case,  $R_{th(j-c)_{electrical}} = 0.6 \text{ } ^\circ\text{C/W}$  (typ.) (All chips operated simultaneously)

Case Temperature ( $T_c$ ) = Temperature at bottom of ceramic substrate.



### Mechanical Dimensions – SBM-40 Emitter

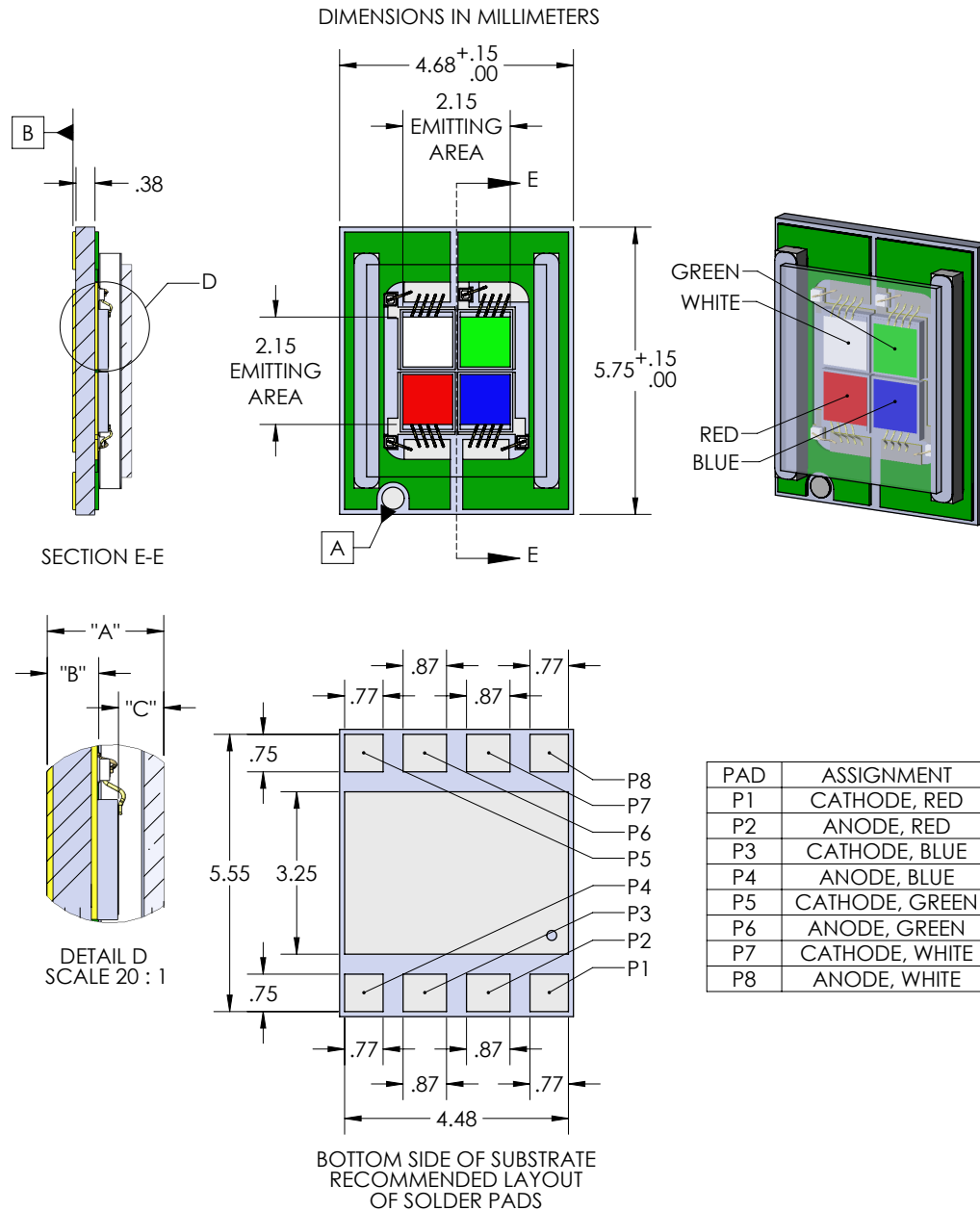

DIMENSION NAME	DESCRIPTION	NOMINAL DIMENSION	TOLERANCE
"A"	BOTTOM OF SUBSTRATE TO TOP OF WINDOW	1.17	±.09
"B"	BOTTOM OF SUBSTRATE TO TOP OF SOLDERMASK	.52	±.05
"C"	TOP OF DIE EMITTING AREA TO TOP OF WINDOW	.45	±.06

DWG-002374

For a detailed drawing, please refer drawing number: DWG -002374

For prototyping purposes, please see Bergquist thermal clad boards, part #803807 (square board) or part # 803808 (star board). Available from Digi-Key or Mouser.

## Solder Profile

SAC 305 Reflow Profile Window For Low Density Boards

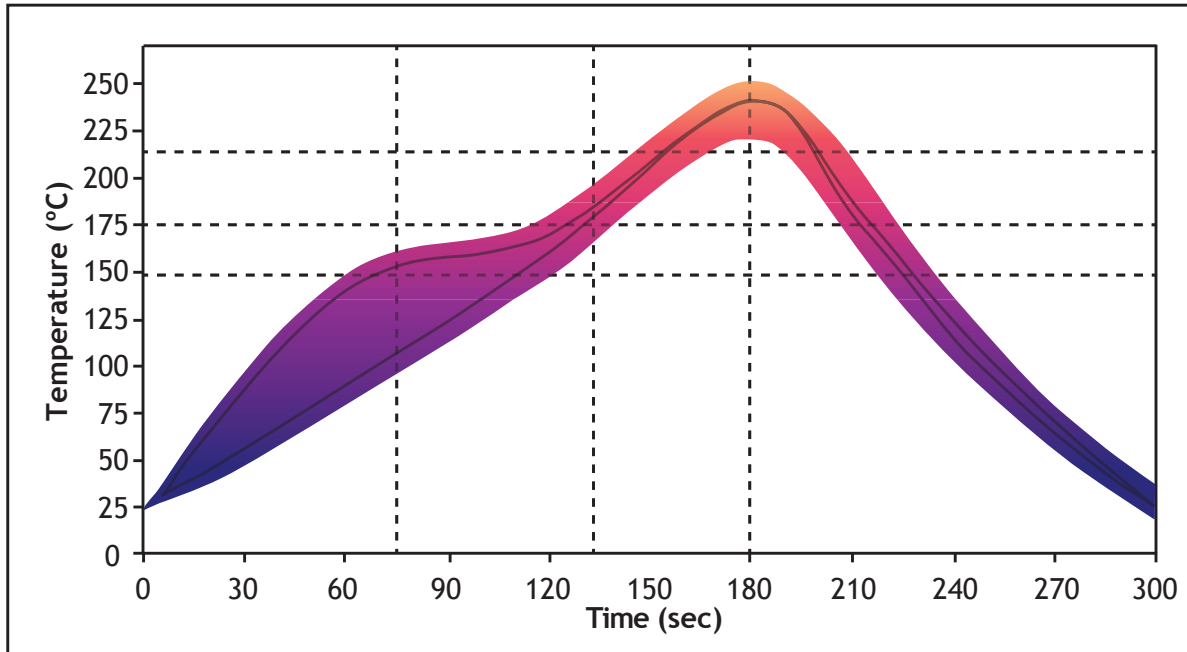

Solder Profile Stage	Lead-Free Solder	Lead-based Solder
Rate of Rise	2°C/sec max	2°C/sec max
Preheat Min Temp ( $T_{i,min}$ )	100°C	120°C
Preheat Max Temp ( $T_{i,max}$ )	175°C	130°C
Preheat Time ( $T_{i,min}$ to $T_{i,max}$ )	90 seconds	120 seconds
Liquidus Min Temp ( $T_L$ )	185°C	160°C
Liquidus to Liquidus Time ( $T_{L1}$ to $T_{L2}$ )	30-60 seconds	30 seconds
Liquidus Peak Temp ( $T_p$ )	240°C max	220°C max
Cooldown	≤ 4°C/sec	≤ 6°C/sec
Profile Length (Ambient to Peak)	4 min	3.5 - 4 min

Note 9: Temperatures are taken and monitored at the component copper layer.

Note 10: Optimum profile may differ due to oven type, circuit board or assembly layout.

Note 11: Recommended lead free, no-clean solder: AIM NC254-SAC305.

Note 12: Refer to soldering and handling application note (APN-001473) for additional solder profiles and details.

### Packaging Specification

Packing Unit = 500 pcs per reel

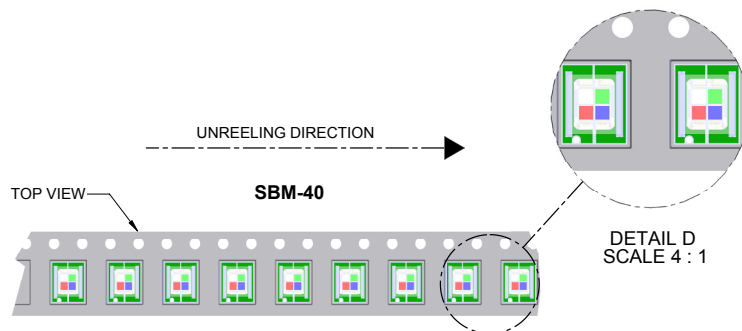
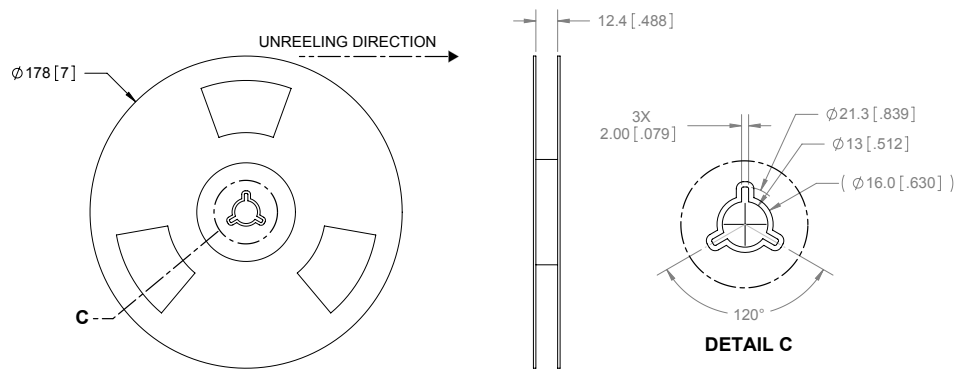
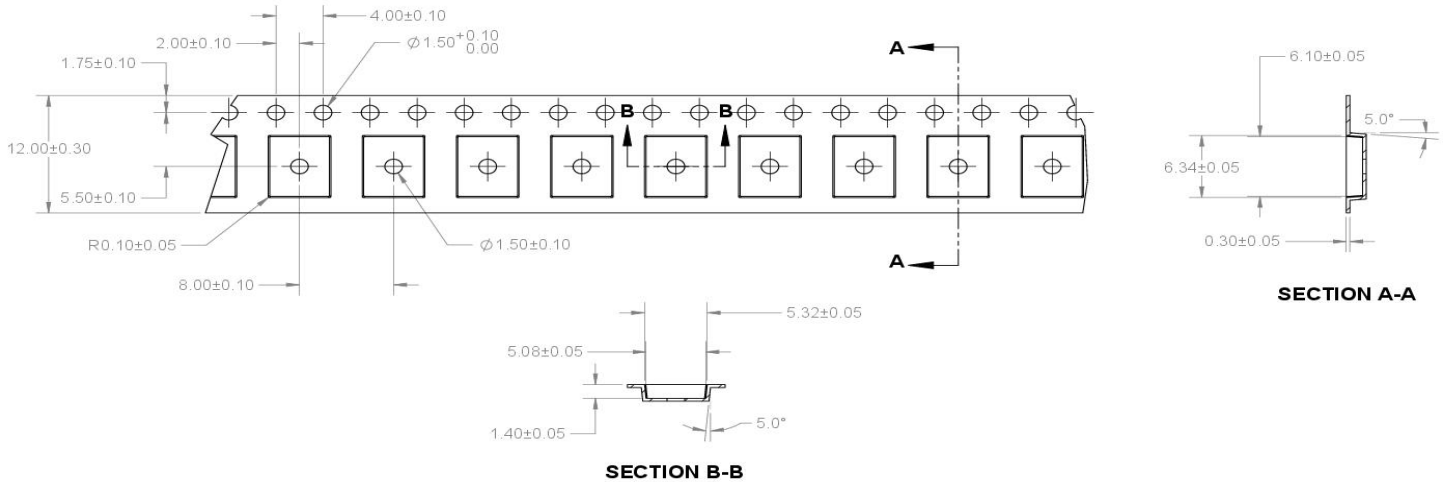

Note 13: For detailed drawing, please refer to drawing number: TO-1156.

### Revision History

Revision	Date	Description
Rev 01	06/24/14	Datasheet release ( Preliminary )
Rev 02	09/30/14	Update Datasheet Specifications and Packaging Specification
Rev 03	10/26/15	Update Datasheet Specifications

The products, their specifications and other information appearing in this document are subject to change by Luminus Devices without notice. Luminus Devices assumes no liability for errors that may appear in this document, and no liability otherwise arising from the application or use of the product or information contained herein. None of the information provided herein should be considered to be a representation of the fitness or suitability of the product for any particular application or as any other form of warranty. Luminus Devices' product warranties are limited to only such warranties as accompany a purchase contract or purchase order for such products. Nothing herein is to be construed as constituting an additional warranty. No information contained in this publication may be considered as a waiver by Luminus Devices of any intellectual property rights that Luminus Devices may have in such information.

This product is protected by U.S. Patents 6,831,302; 7,074,631; 7,083,993; 7,084,434; 7,098,589; 7,105,861; 7,138,666; 7,166,870; 7,166,871; 7,170,100; 7,196,354; 7,211,831; 7,262,550; 7,274,043; 7,301,271; 7,341,880; 7,344,903; 7,345,416; 7,348,603; 7,388,233; 7,391,059 Patents Pending in the U.S. and other countries.