

## SPECIFICATION

Part No.	:	<b>SDWA.01</b>
Product Name	:	Dual-Band 2.4/5GHz Wi-Fi Ceramic SMD Antenna
Features	:	High Efficiency/ High Peak Gain 2400 MHz to 2483 MHz - Peak Gain 3.5 dBi 5180 MHz to 5825 MHz - Peak Gain 4.2 dBi Low Profile 10*4*1.5mm RoHS ✓

Photo



## 1. Introduction

The SDWA.01 dual-band SMT ceramic antenna is an embedded, high efficiency, high peak gain solution for Wi-Fi 802.11n and other ISM band applications which require high-speed data rates and wide coverage areas. Designed for the 2.4 GHz and 5 GHz bands, the antenna delivers a peak gain of 3.5 dBi and 4.2 dBi, respectively. The antenna features excellent efficiency > 70% in both bands. It is designed to perform optimally mounted in the corner of a device PCB. Two SDWA.01 antennas can be used for MIMO applications. The antenna's low profile, at only 1.5mm, allows for use on extremely thin devices while still maintaining excellent performance characteristics. This antenna is delivered on Tape and Reel for SMT application.

Many module manufacturers specify peak gain limits for any antennas that are to be connected to that module. Those peak gain limits are based on free-space conditions. In practice, the peak gain of an antenna tested in free-space can degrade by at least 1 or 2dBi when put inside a device. So ideally you should go for a slightly higher peak gain antenna than mentioned on the module specification to compensate for this effect, giving you better performance.

Upon testing of any of our antennas with your device and a selection of appropriate layout, integration technique, or cable, Taoglas can make sure any of our antennas' peak gain will be below the peak gain limits. Taoglas can then issue a specification and/or report for the selected antenna in your device that will clearly show it complying with the peak gain limits, so you can be assured you are meeting regulatory requirements for that module.

For example, a module manufacturer may state that the antenna must have less than 2dBi peak gain, but you don't need to select an embedded antenna that has a peak gain of less than 2dBi in free-space. This will give you a less optimized solution. It is better to



go for a slightly higher free-space peak gain of 3dBi or more if available. Once that antenna gets integrated into your device, performance will degrade below this 2dBi peak gain due to the effects of GND plane, surrounding components, and device housing. If you want to be absolutely sure, contact Taoglas and we will test. Choosing a Taoglas antenna with a higher peak gain than what is specified by the module manufacturer and enlisting our help will ensure you are getting the best performance possible without exceeding the peak gain limits.

## 2. Specification

ELECTRICAL		
Band	2.4 GHz	5GHz
Frequency (MHz)	2400-2483	5180-5825
Polarization	Linear	
Impedance (Ohms)	50 Ohms	
Efficiency (%)	83	75
Return Loss (dB)	-9.29	-10.12
Radiation Properties	Omni-directional	
VSWR	2	2
Peak Gain (dBi)	3.5	4.2

**Note:**

These values are based on our standard 100mm\*50mm test board. Actual electrical values will change depending on ground plane size, shape, mounting position, matching circuit design, and surrounding environment.

MECHANICAL	
Dimensions	10x4x1.5mm
ENVIRONMENTAL	
Operation Temperature	-40°C to +85°C
Storage Temperature	-40°C to +105°C
Temperature Coefficient ( $\tau f$ )	0 $\pm$ 20 ppm @-20°C to +80°C
Humidity	Non-condensing 65°C 95% RH
Recommended Reel Storage Conditions	5°C to 40°C Relative Humidity 20% to 70%

### 3. Test Setup

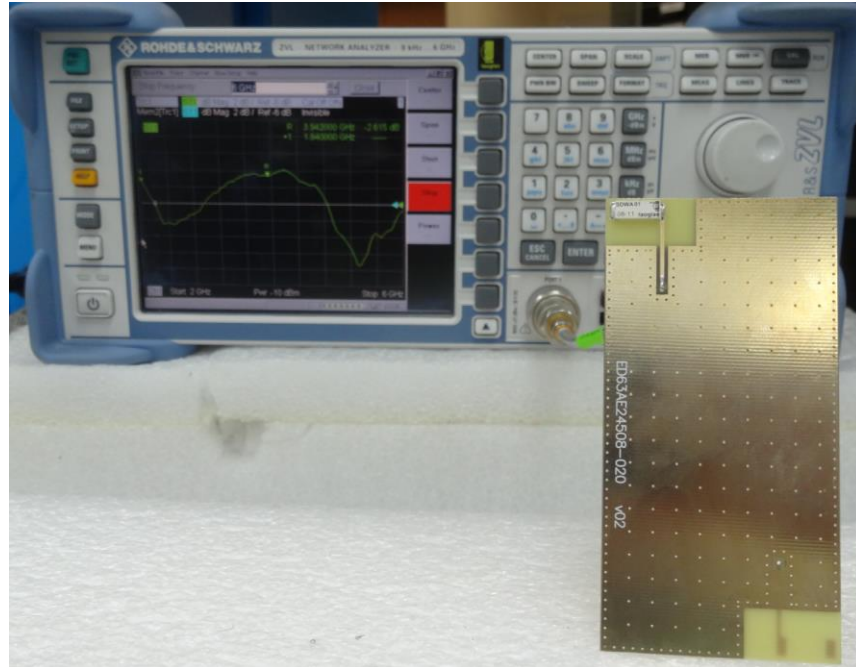

Figure 1. Impedance measurement setup.

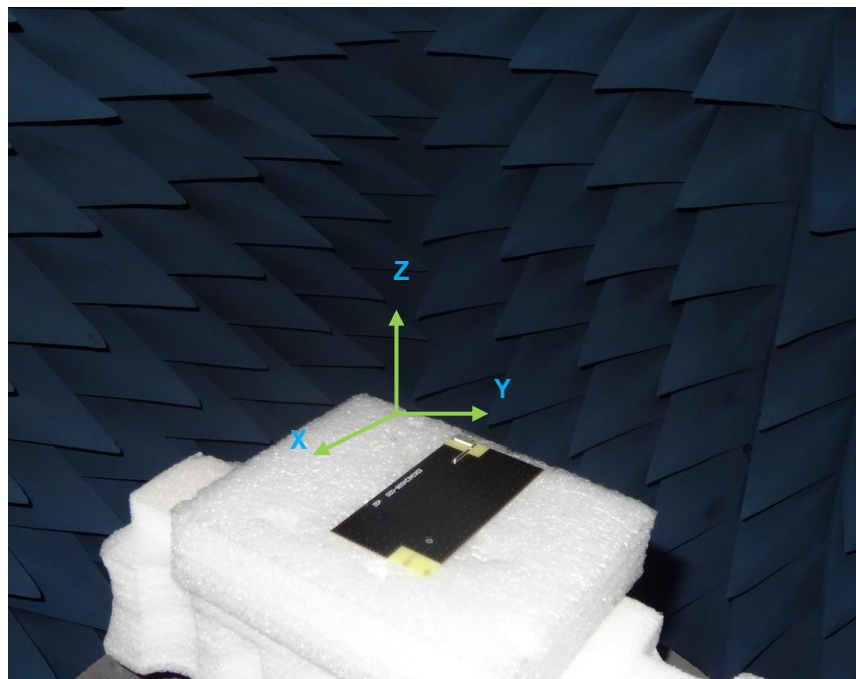

Figure 2. Peak gain, efficiency, and radiation pattern measurement

## 4. Antenna Parameters

### 4.1. Return Loss

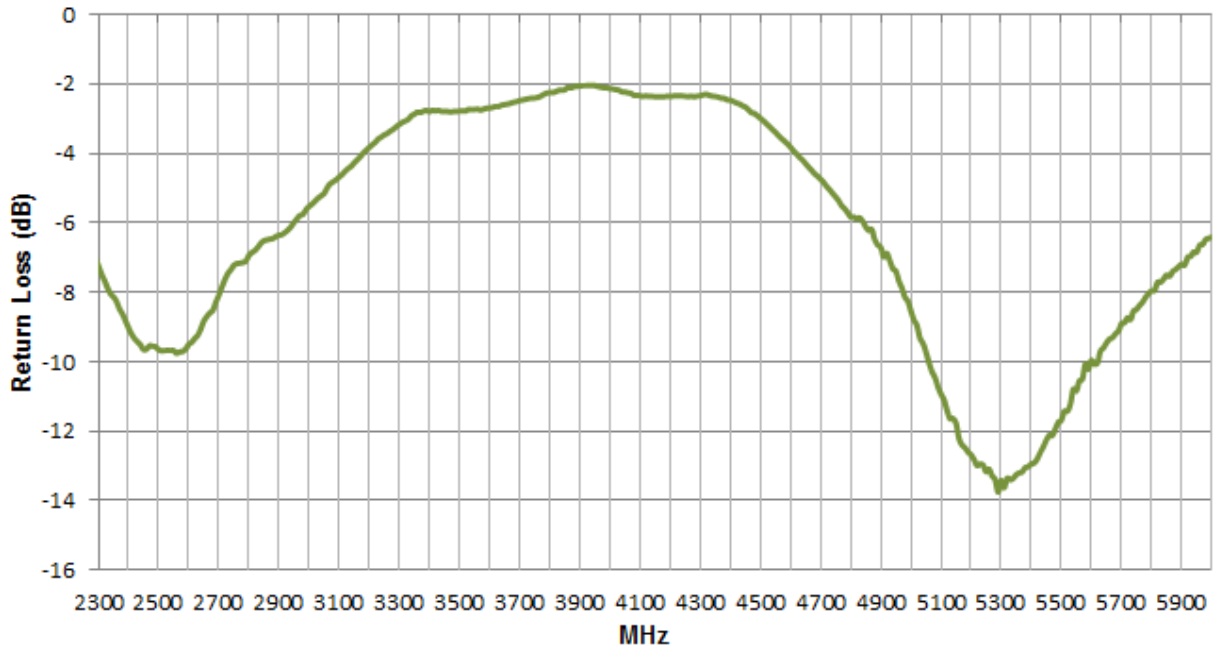

Figure 3. Return Loss of the SDWA.01 antenna.

### 4.2 VSWR

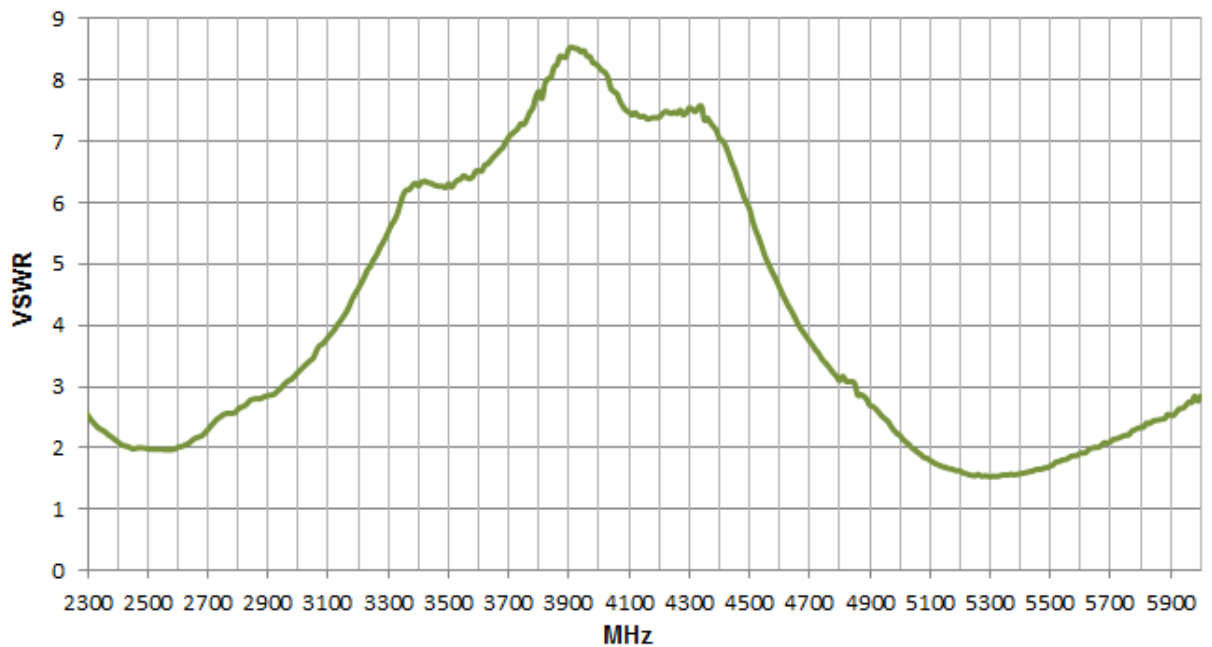

Figure 4. VSWR of the SDWA.01 antenna.

### 4.3. Efficiency

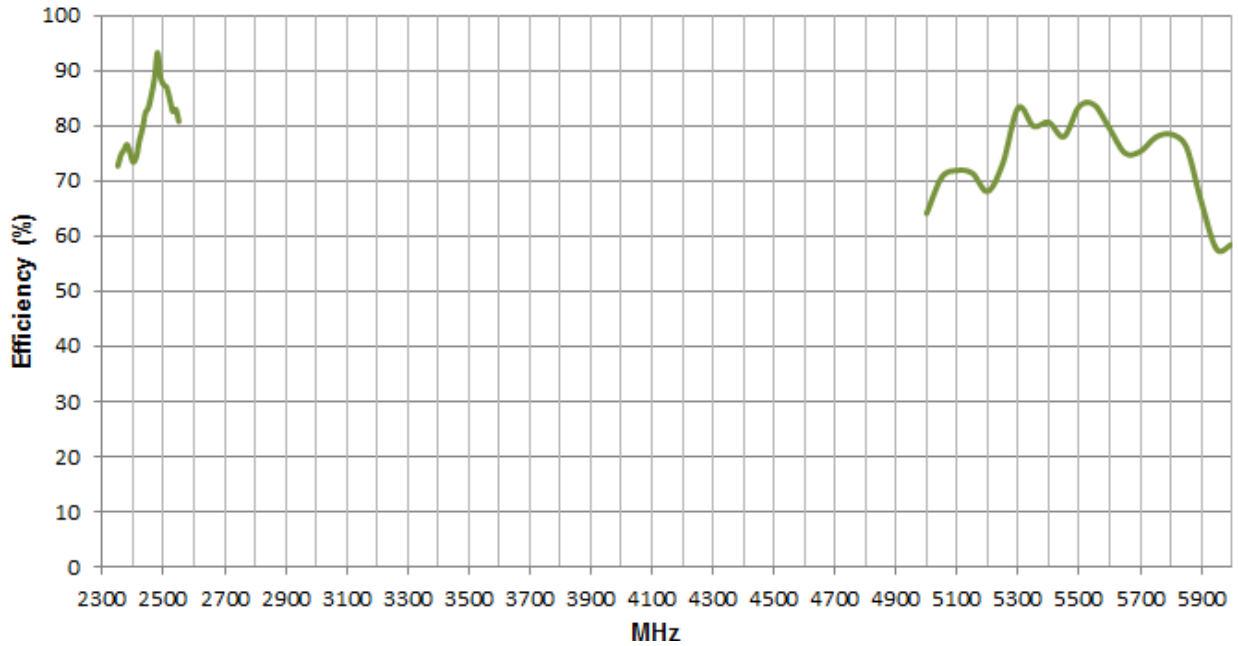

Figure 5. Efficiency of the SDWA.01 antenna.

### 4.4. Peak Gain

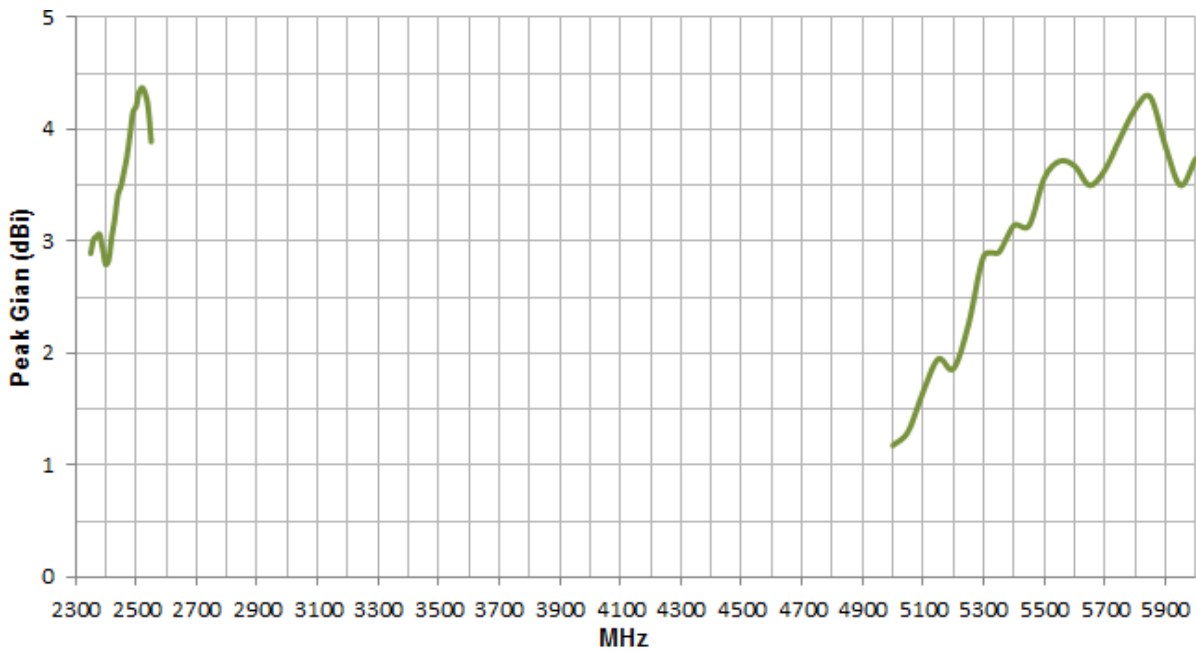

Figure 6. Peak gain of the SDWA.01 antenna.

### 4.5. Average Gain

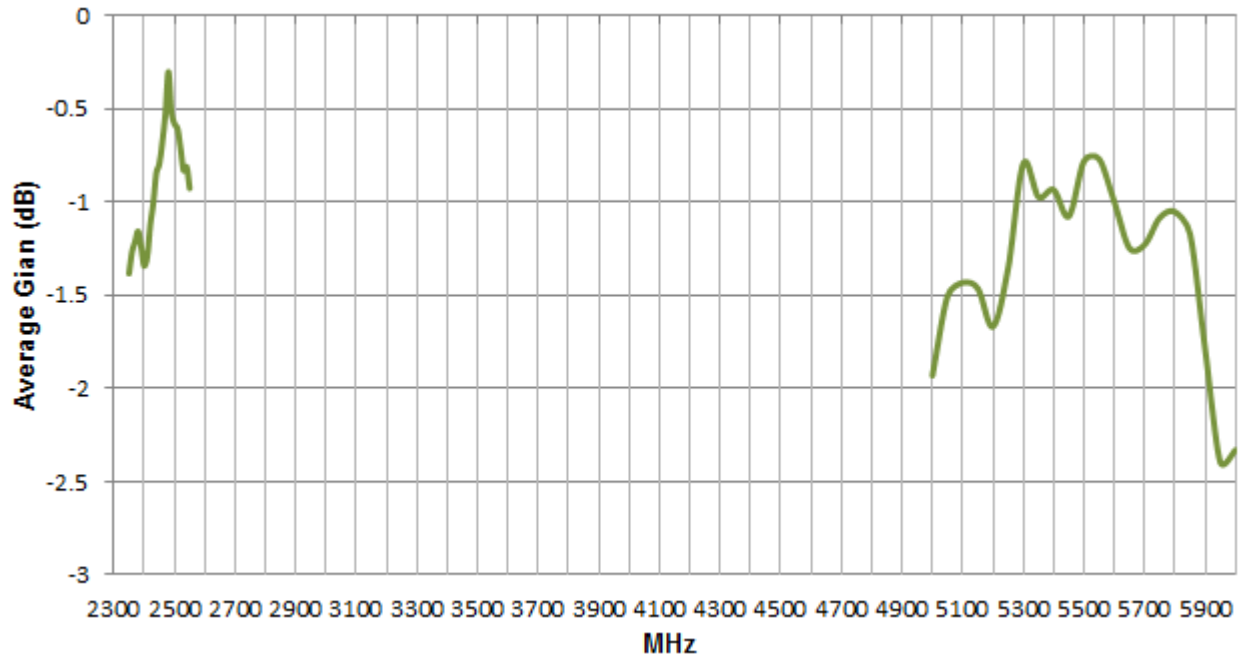

Figure 7. Average gain of the SDWA.01 antenna.

### 4.6. 3D Radiation Pattern

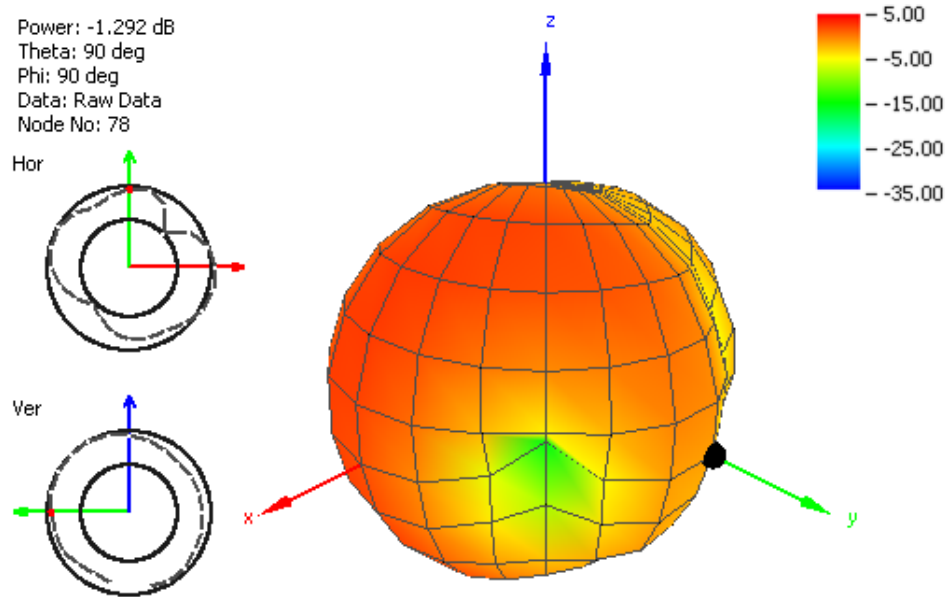
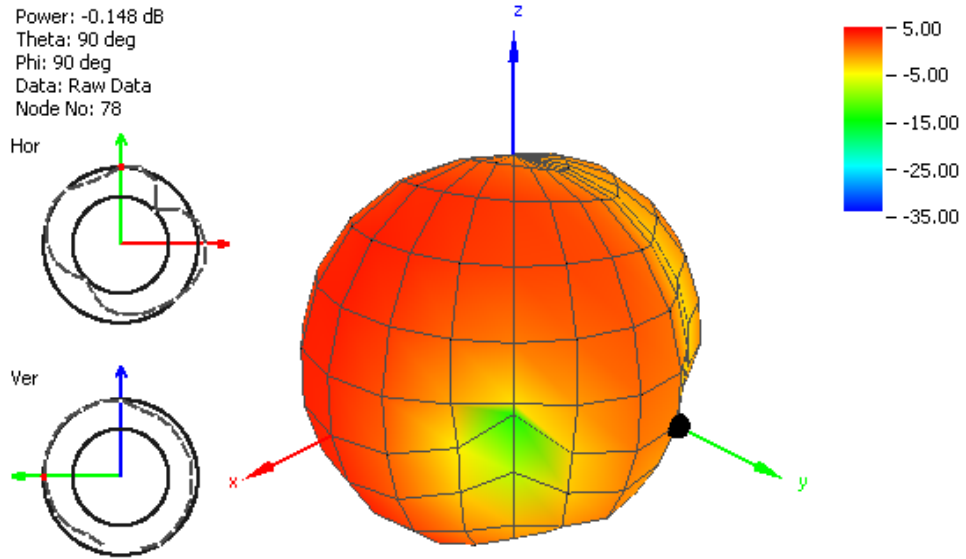
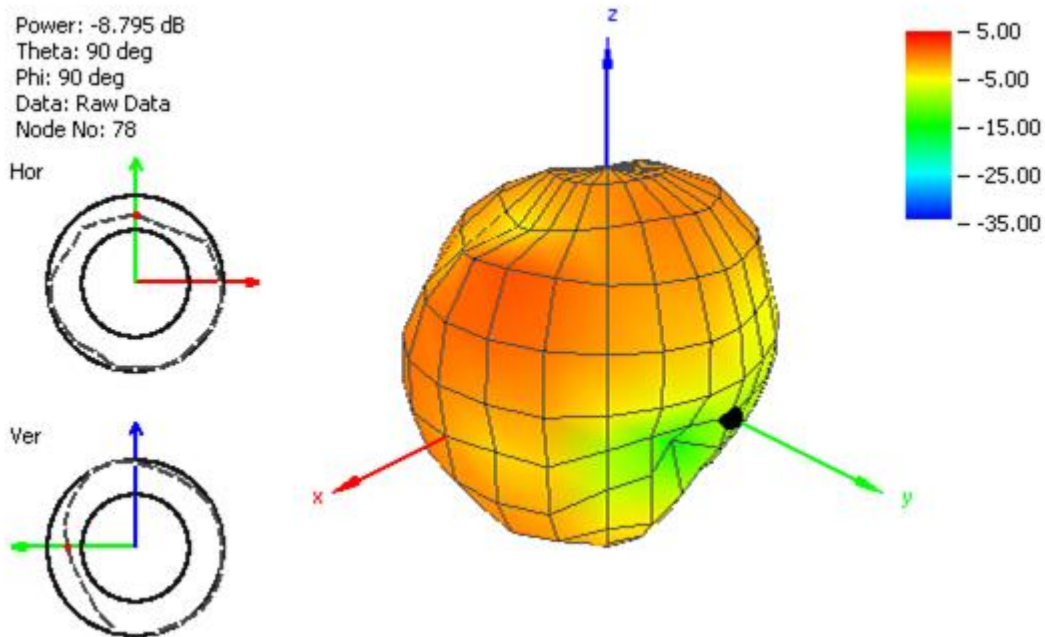

Figure 8. Radiation Pattern at 2400 MHz of the SDWA.01 antenna.

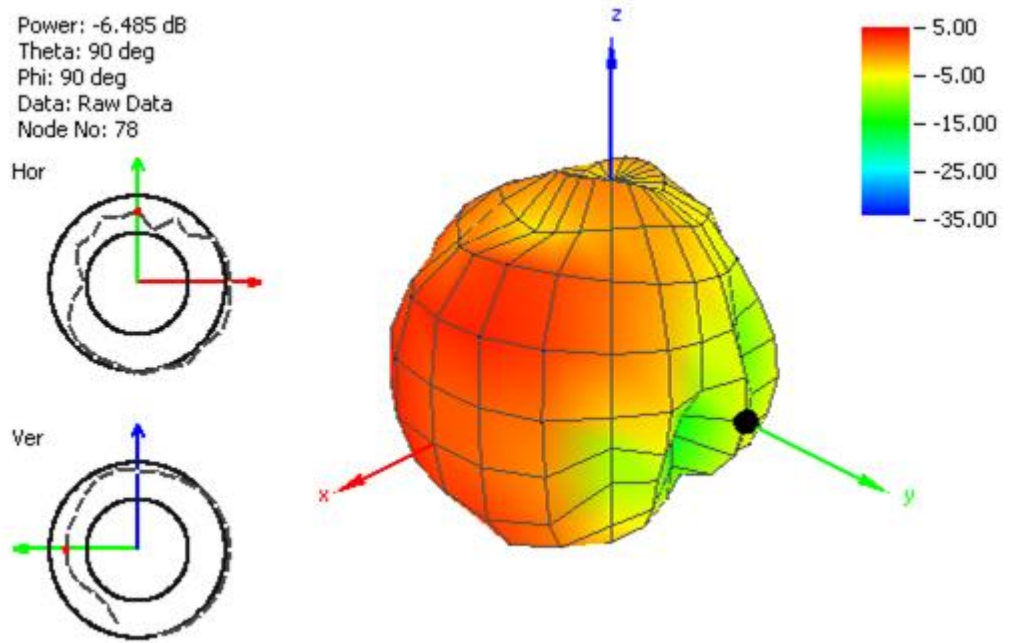



**Figure 9. Radiation Pattern at 2480 MHz of the SDWA.01 antenna.**

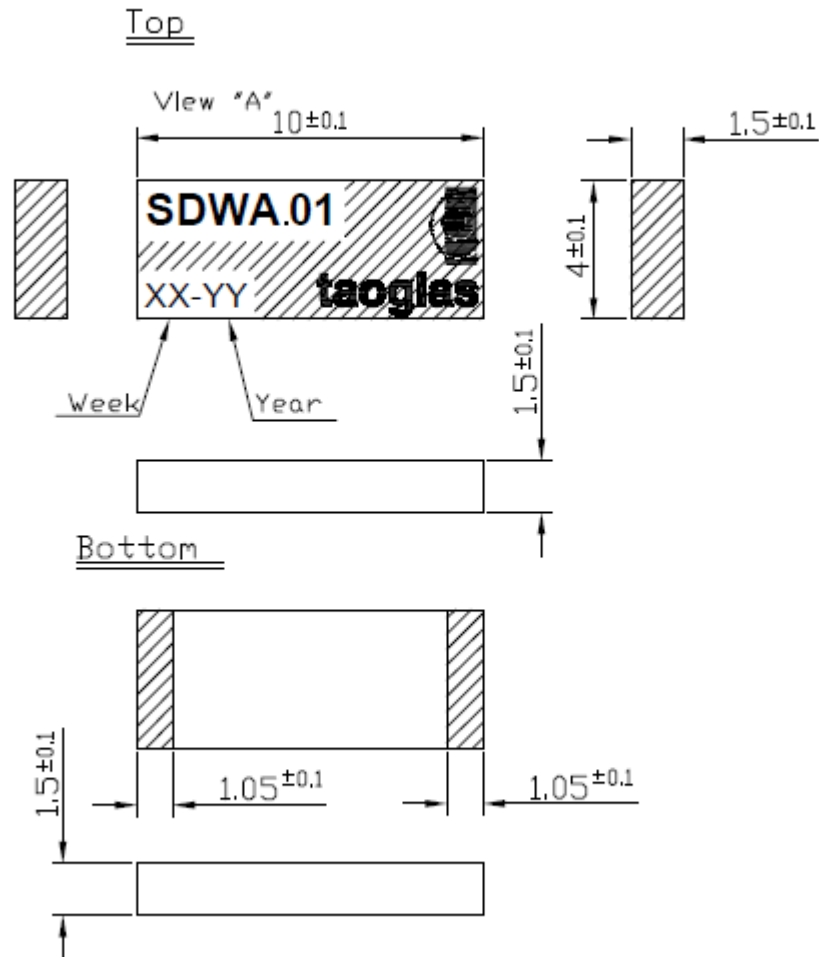

**Figure 10. Radiation Pattern at 5200 MHz of the SDWA.01 antenna.**



**Figure 11. Radiation Pattern at 5700 MHz of the SDWA.01 antenna.**

## 5. Drawings and Dimensions





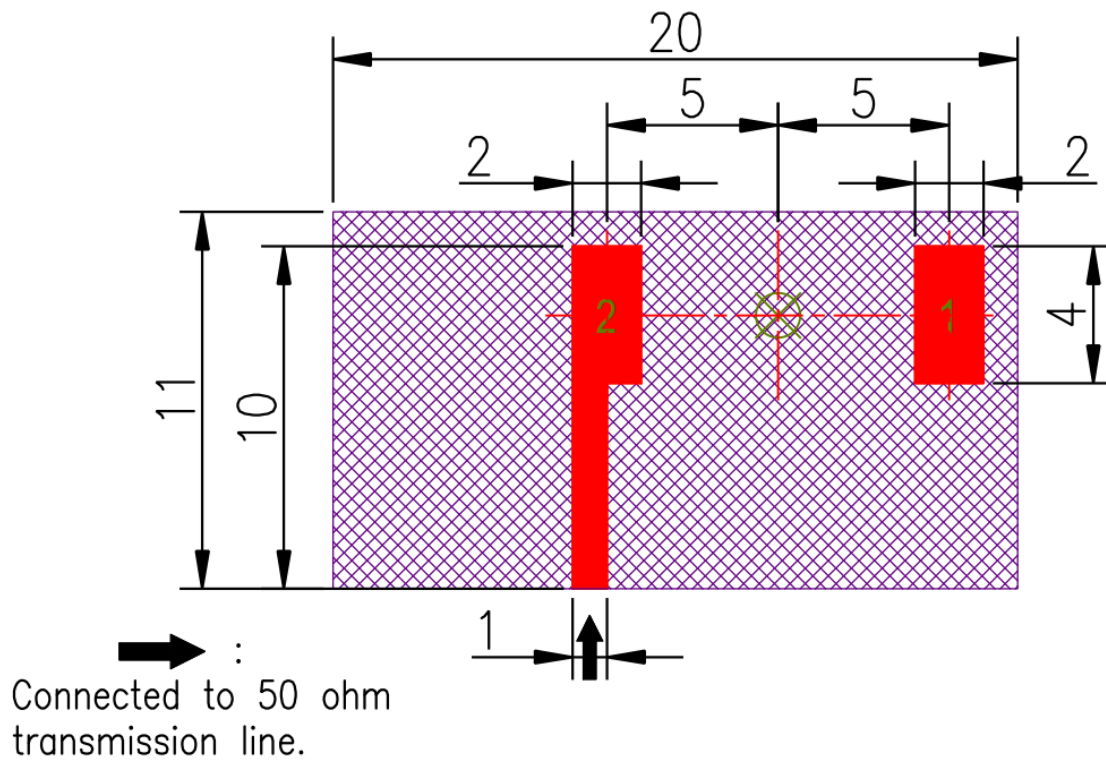

## 5.1 Antenna Footprint

### 5.1.1 Top Copper



#### NOTE:

- |                        |   |
|------------------------|---|
| 1. Ag Plated area      |  |
| 2. Solder Mask area    |  |
| 3. Copper area         |  |
| 4. Paste area          |  |
| 5. Copper Keepout Area |  |
6. Copper keepout should extend through all PCB layers.
  7. Any vias in pads should be either filled or tented to prevent solder from wicking away from the pad during reflow.
  8. The dimension tolerances should follow standard PCB manufacturing guidelines
  9. The transmission line width may change once it gets to the ground plane edge depending on PCB details and the transmission line that runs through the keepout area should always be 1.00mm.
  10. The antenna footprint can be mirrored for customer's application.

### 5.1.2 Top Solder Paste

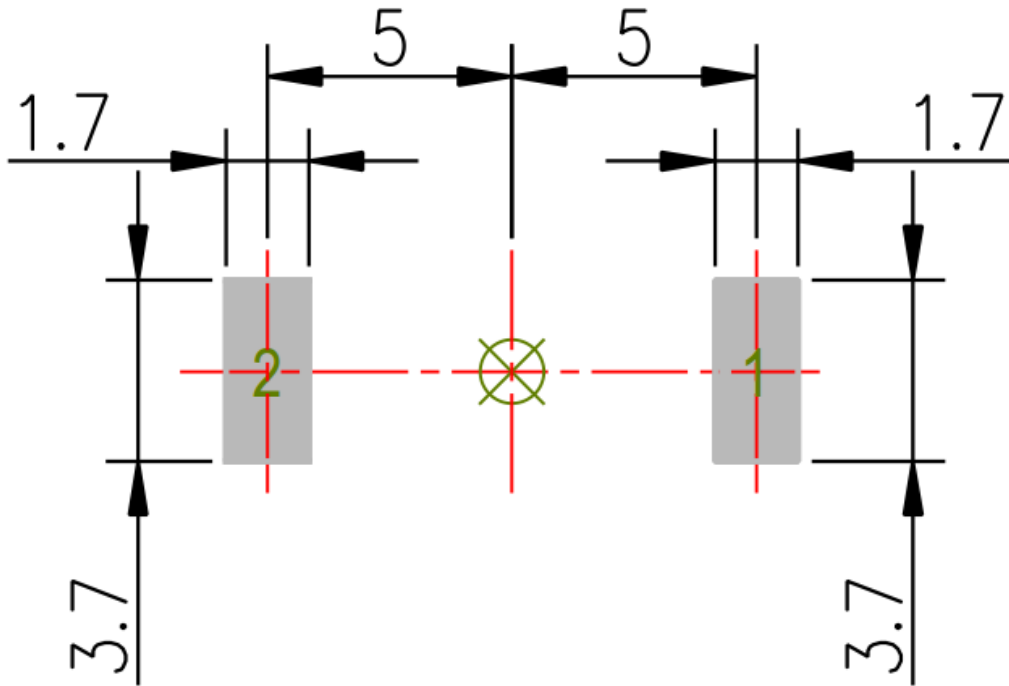

NOTE:

- 1. Ag Plated area
- 2. Solder Mask area
- 3. Copper area
- 4. Paste area
- 5. Copper Keepout Area



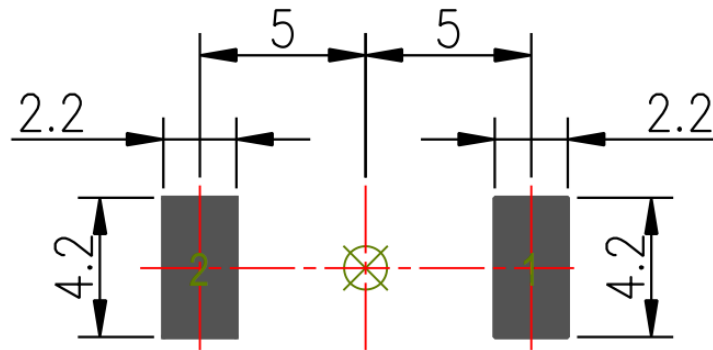

- 6. Copper keepout should extend through all PCB layers.
- 7. Any vias in pads should be either filled or tented to prevent solder from wicking away from the pad during reflow.
- 8. The dimension tolerances should follow standard PCB manufacturing guidelines
- 9. The transmission line width may change once it gets to the ground plane edge depending on PCB details and the transmission line that runs through the keepout area should always be 1.00mm.
- 10. The antenna footprint can be mirrored for customer's application.

### 5.1.3 Top Solder Mask

This drawing is a negative of solder mask. Black regions are anti-mask.



#### NOTE:

- |                        |   |
|------------------------|---|
| 1. Ag Plated area      |  |
| 2. Solder Mask area    |  |
| 3. Copper area         |  |
| 4. Paste area          |  |
| 5. Copper Keepout Area |  |
6. Copper keepout should extend through all PCB layers.
  7. Any vias in pads should be either filled or tented to prevent solder from wicking away from the pad during reflow.
  8. The dimension tolerances should follow standard PCB manufacturing guidelines
  9. The transmission line width may change once it gets to the ground plane edge depending on PCB details and the transmission line that runs through the keepout area should always be 1.00mm.
  10. The antenna footprint can be mirrored for customer's application.

### 5.1.4 Composite Diagram

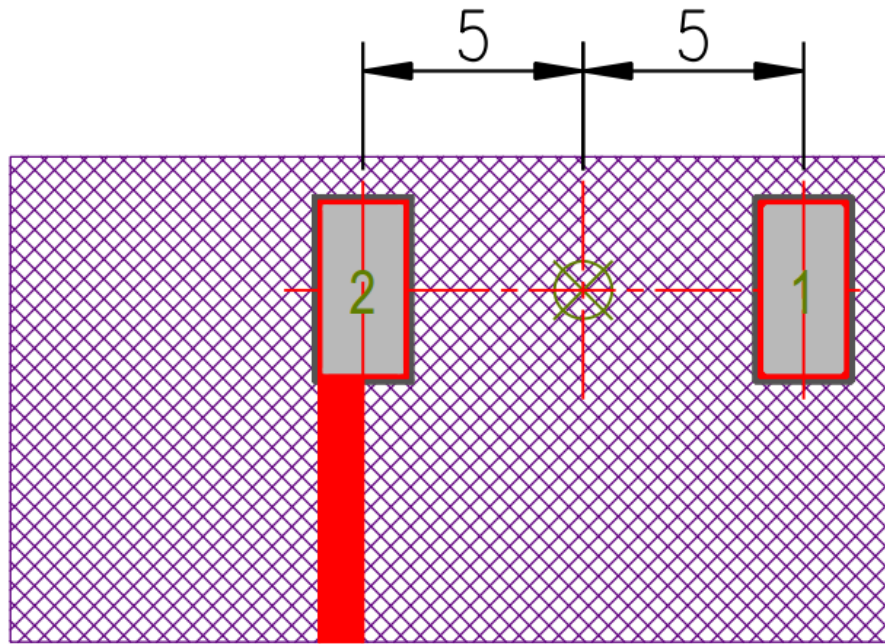

## 6. Test Board Dimensions

The test Board is designed for evaluation purposes.

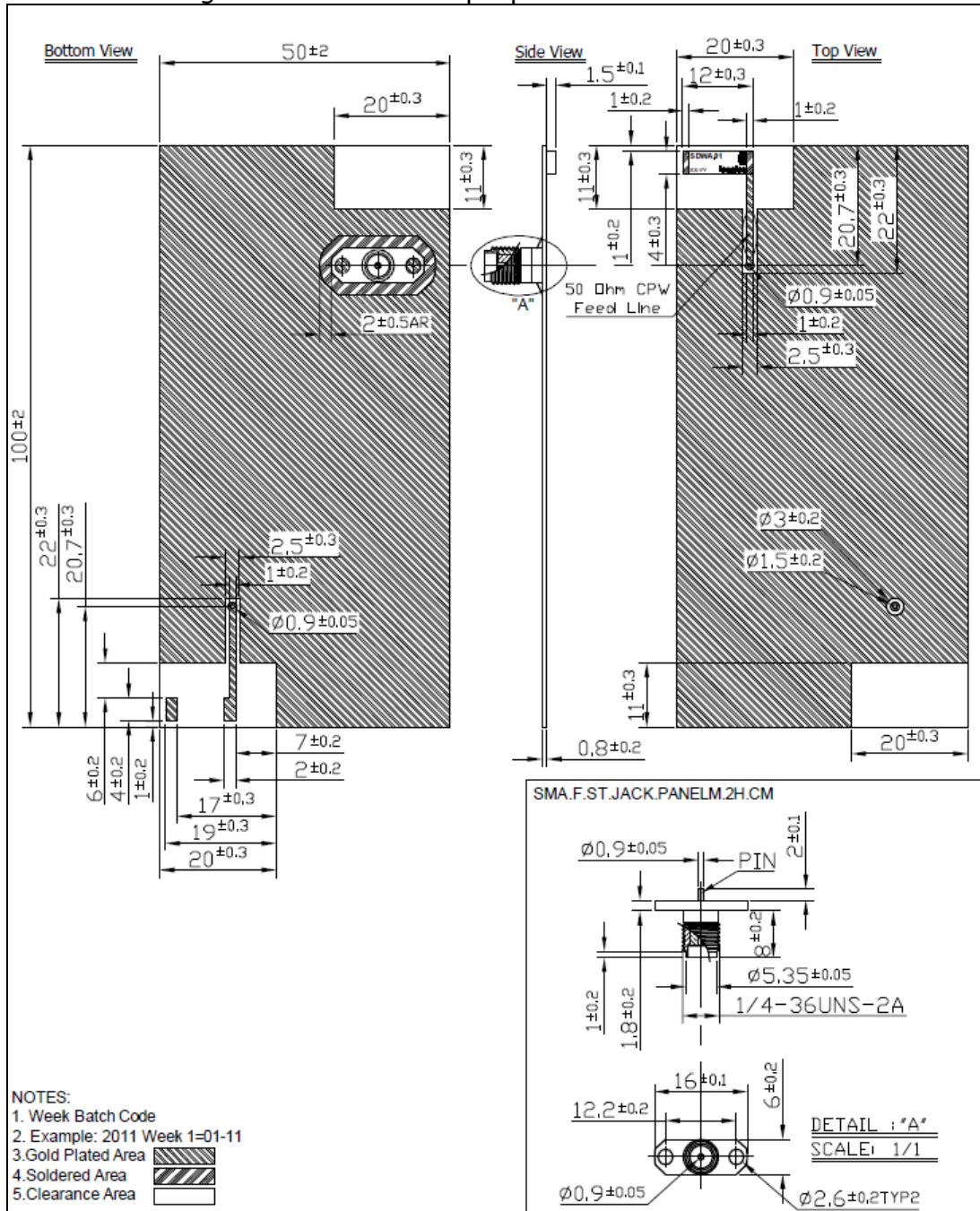

The size of the ground plane for the complete evaluation board is 100x50 mm. The area occupied by the antenna is 20x11mm.



## 7. Matching Circuit

Like all antennas, surrounding components, enclosures, and changes to the GND plane dimensions can alter performance. A pi-matching network like the one shown below is required in case adjustments need to be made. Make S1 a zero ohm resistor and leave S2 and S3 unpopulated when building first prototypes. These components will likely need to be adjusted upon integration to provide the best match between the antenna and transmission line. The additional zero ohm resistor in the diagram is needed for the ability to solder down a coax pigtail to make measurements with a vector network analyzer.

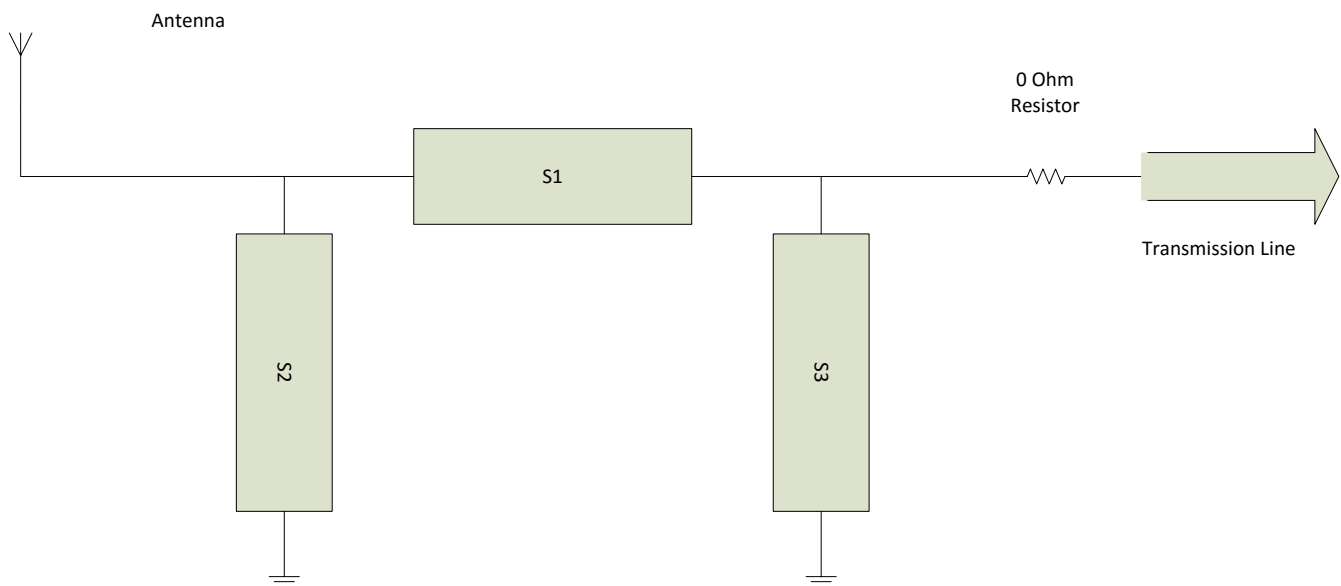

## Recommended Soldering Conditions

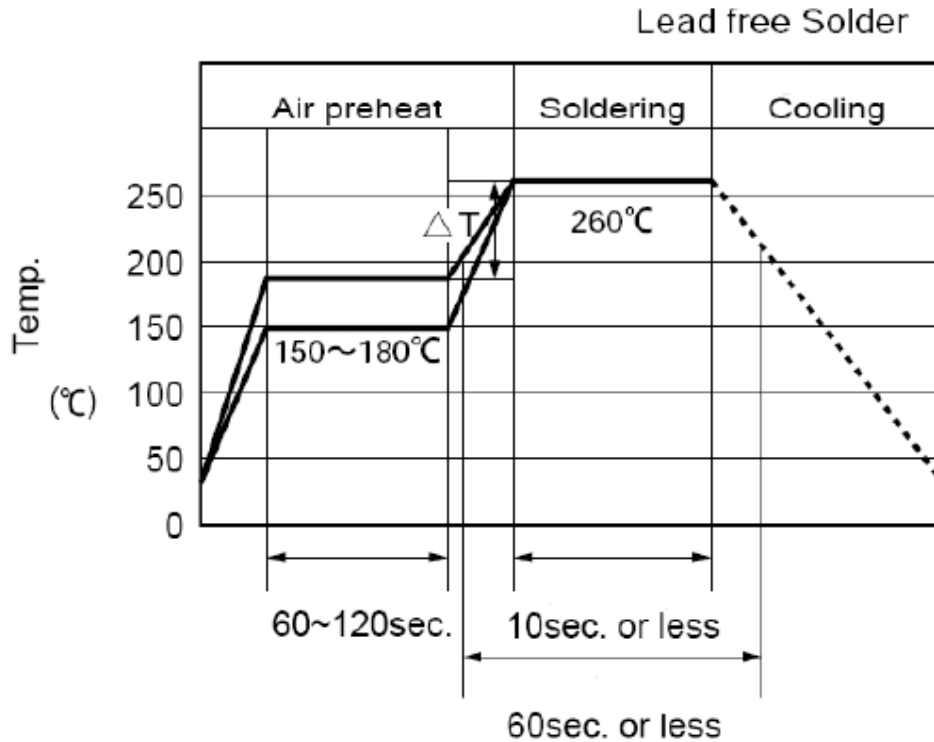

1. Time shown in the above figures is measured from the point when chip surface reaches temperature.
2. Temperature difference in high temperature part should be within 110°C.
3. After soldering, do not force cool, allow the parts to cool gradually.

### \*General attention to soldering:

- High soldering temperatures and long soldering times can cause leaching of the termination, decrease in adherence strength, and the change of characteristic may occur.
- for soldering, please refer to the soldering curves above. However, please Keep exposure to temperatures exceeding 200°C to under 50 seconds.
- please use a mild flux (containing less than 0.2wt% Cl). Also, if the flux is water soluble, be sure to wash thoroughly to remove any residue from the underside of components that could affect resistance.

### Cleaning:

When using ultrasonic cleaning, the board may resonate if the output power is too high. Since this vibration can cause cracking or a decrease in the adherence of the termination, we recommend that you use the conditions below.

- Frequency: 40 kHz max.
- Output power: 20W/Iiter
- Cleaning time: 5minutes max.

## 9. Delivery Mode

1. Blister tape to IEC 286-3 · polyester ·
2. Pieces/tape: 2000

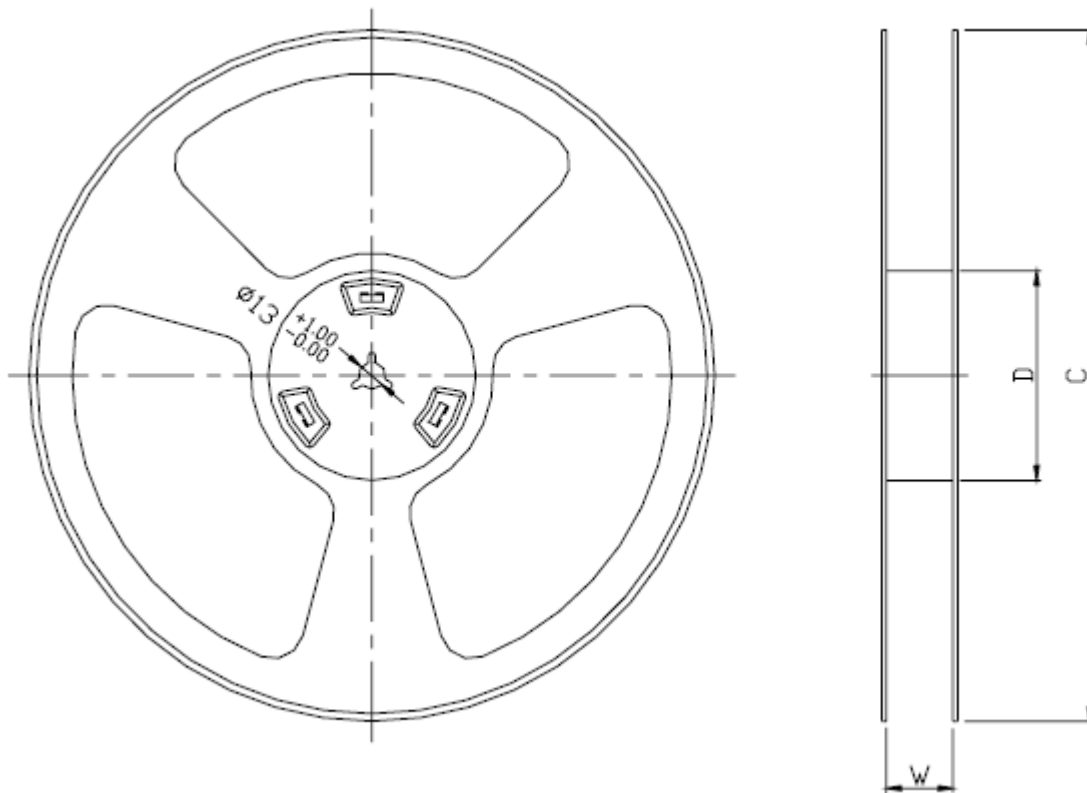

Product Code	Units per Reel	C(mm)	D(mm)	W(mm)
Antenna	2000	330±1	100±0.5	24±1

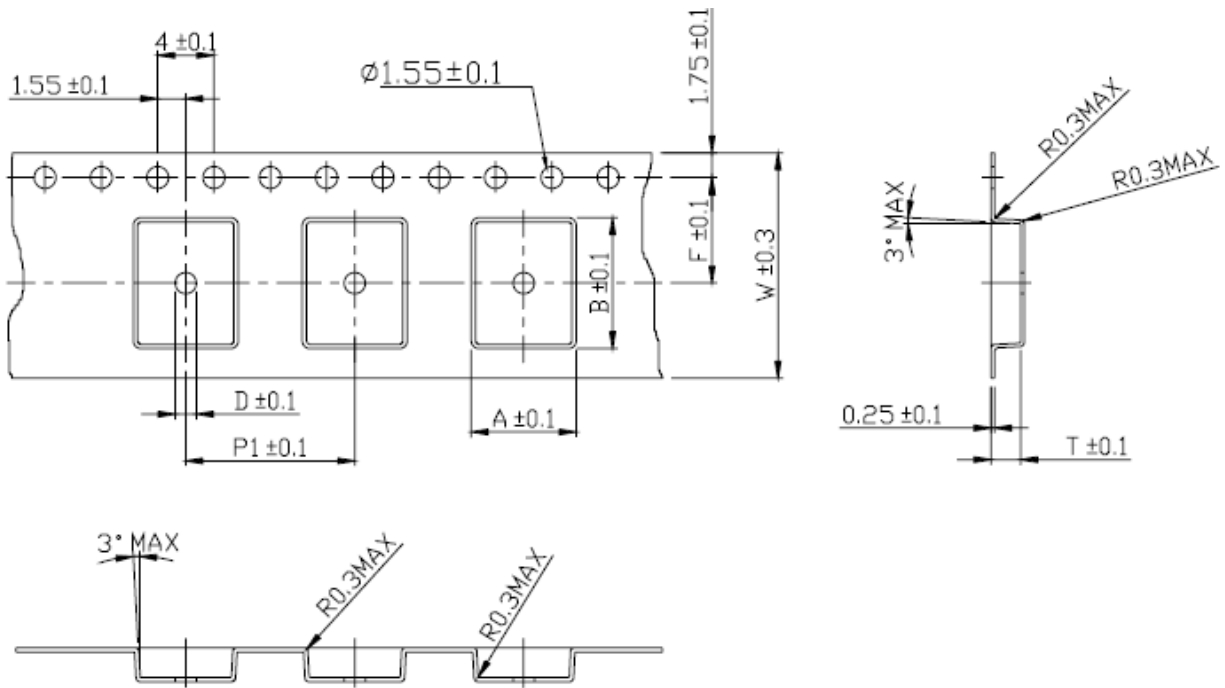

No	Index	Spec(mm)
1	A	4.6
2	B	10.6
3	P1	12
4	W	24
5	F	8.5
6	T	2.5
7	D	1.5