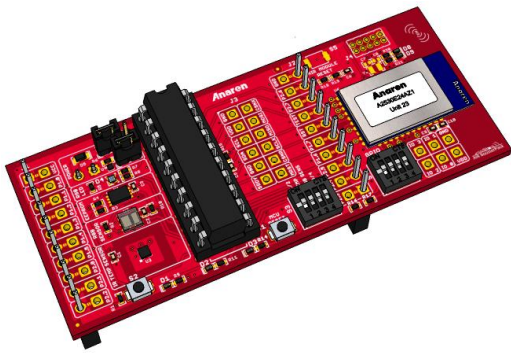


# Anaren®

What'll we think of next?®



## Anaren Integrated Radio

### AIR BoosterPack User's Manual

A2530R24A  
A2530E24A

Release Date 11/2/12



Anaren Integrated Radio

**THIS PAGE LEFT INTENTIONALLY BLANK**

# USER'S MANUAL

## AIR BoosterPack

### Contents

1.	AIR BoosterPack Overview .....	5
1.1.	Overview .....	5
1.2.	Kit Contents .....	6
2.	Getting Started with the AIR BoosterPack.....	7
2.1.	Hardware Installation.....	9
2.1.1.	AIR BoosterPack with MSP430 LaunchPad.....	9
2.1.2.	AIR BoosterPack with Stellaris LaunchPad.....	11
2.2.	USB Driver Installation.....	13
2.3.	Programming the Demo Application on Stellaris.....	17
2.4.	IMPORTANT: Required Radio Setup .....	19
2.5.	Using the Demo Application .....	20
2.6.	AIR A2530 Wiki.....	20
3.	AIR BoosterPack Hardware .....	21
3.1.	Electrical Characteristics .....	21
3.1.1.	Absolute Maximum Ratings .....	21
3.1.2.	Recommended Operating Conditions.....	21
3.2.	Functional Description .....	22
3.2.1.	A2530 Radio Module (U6).....	23
3.2.2.	MCU & Socket (U5) .....	23
3.2.3.	Sensors .....	23
3.2.4.	Serial EEPROM (U1) .....	24
3.2.5.	LED Indicators.....	24
3.2.6.	Switches.....	25
3.2.7.	Jumpers.....	28
3.2.8.	Connectors.....	31
3.3.	Schematics .....	35
3.4.	PCB Layout .....	37
3.5.	Bill of Materials (BOM).....	41



**THIS PAGE LEFT INTENTIONALLY BLANK**

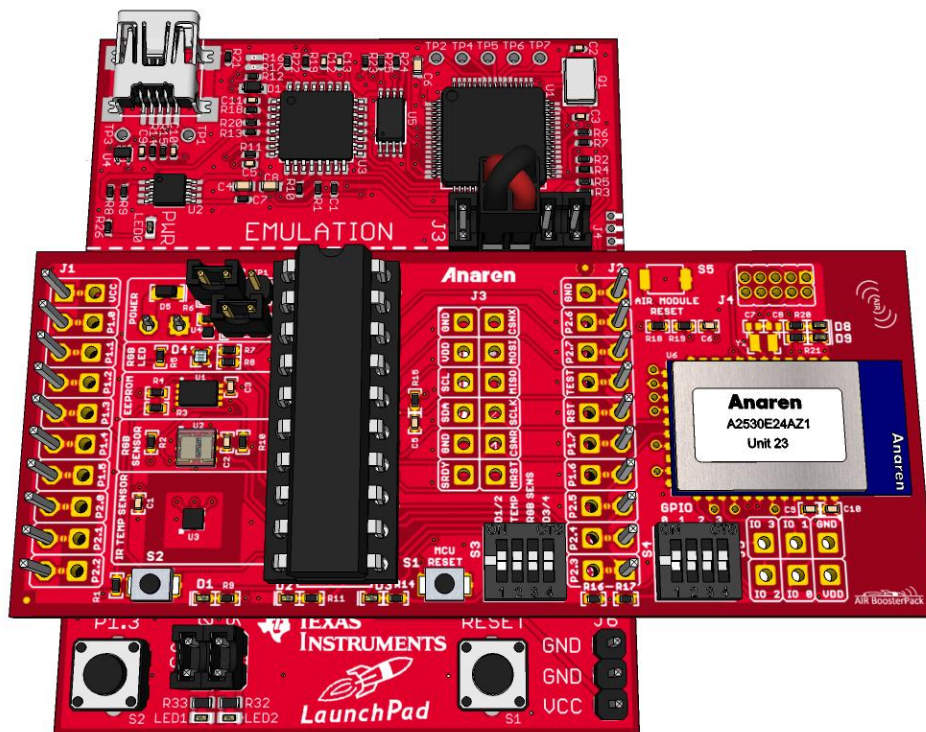
# 1. AIR BoosterPack Overview

## 1.1. Overview

The AIR BoosterPack is a low-power wireless transceiver extension module for use with the Texas Instruments MSP-EXP430G2 and EK-LM4F120XL LaunchPad development kits. The BoosterPack is available in various configurations, each of which contains an AIR radio module with integrated antenna. See Table 1 for a listing of the supported BoosterPacks and their operating bands. The included AIR BoosterPack software applications demonstrate example sensor networks, as well as providing basic examples for communicating with the radio module.

*Table 1 - AIR BoosterPack Models*

Model	Operating Band	Range Extender
A2530R24A	2400-2483.5MHz ISM Band (FCC/IC, ETSI)	No
A2530E24A	2400-2483.5MHz ISM Band (FCC/IC, ETSI)	Yes



*Figure 1 - AIR BoosterPack with MSP430 LaunchPad*



**AIR BoosterPack Hardware Features:**

- 2.7V to 3.6 V operation (2.2V min when RGB Light Sensor power disabled)
- Low power consumption
- SPI interface to Radio Module
- IR Temperature Sensor (TI TMP006)
- RGB Light Sensor (TAOS TCS3414)
- EEPROM (16K x 8)
- Analog Current Monitor
- Tri-Color LED with PWM control
- Accessible Test Points for all MCU ports plus four Radio Module ports
- 8 DIP Switches for board configuration and user input
- 20-pin DIP socket for operation with or without MSP430 microcontroller (MCU removed when used with the Stellaris LaunchPad)
- ROHS compliant
- See AIR Module Users Manual for radio specific features

**AIR BoosterPack Software Features:**

- Texas Instruments ZNP protocol
- Mesh network topology with one Coordinator, one or more Routers, and one or more End Points

## 1.2. Kit Contents

The AIR BoosterPack kit includes the following:

- Three AIR BoosterPacks (each with MSP430G2553 device preinstalled and preloaded with a sample program)
- One AA battery pack with On/Off switch and JST style connector
- Quick Start Guide for use with MSP430 LaunchPad
- Quick Start Guide for use with Stellaris LaunchPad
- Regulatory Guide
- CD containing AIR BoosterPack demo applications, USB UART device drivers, board design files, and supporting documentation



## 2. Getting Started with the AIR BoosterPack

The following sections describe the necessary steps to get the AIR BoosterPack hardware and software up and running with the LaunchPad.

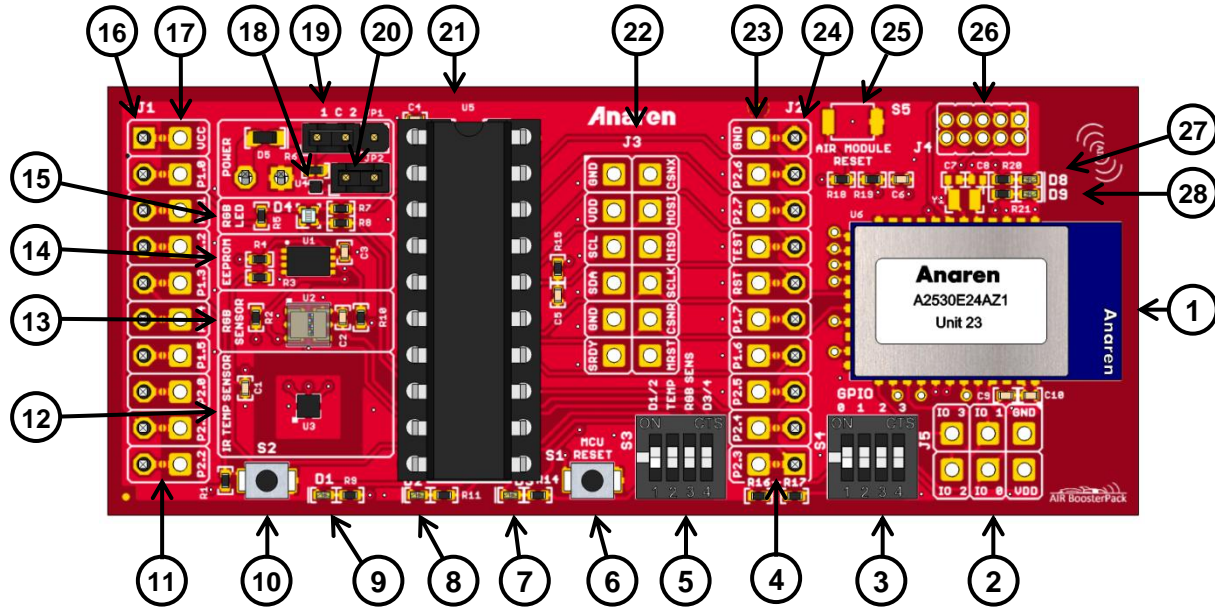
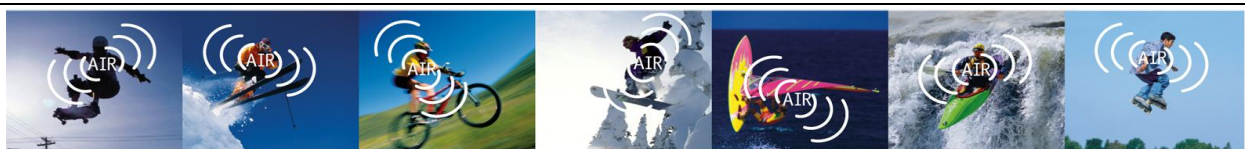


Figure 2 - AIR BoosterPack Overview

- 1 AIR Radio Module (U6).
- 2 Radio GPIO Test Points (J5).
- 3 Radio GPIO DIP Switches (S4).
- 4 J2 Test Point Solder Jumpers.
- 5 Sensor/LED DIP Switches (S3).
- 6 MCU (MSP430) Reset Pushbutton Switch (S1). Duplicate of S1 on MSP430 LaunchPad.
- 7 Yellow LED (D3).
- 8 Green LED (D2). Duplicate of LED2 on MSP430 LaunchPad.
- 9 Red LED (D1). Duplicate of LED1 on MSP430 LaunchPad.
- 10 Pushbutton Switch (S2). Duplicate of S2 on MSP430 LaunchPad.
- 11 J1 Test Point Solder Jumpers.



- ⑫ IR Temperature Sensor (U1).
- ⑬ RGB Light Sensor (U2).
- ⑭ 128Kb (16K x 8) Serial EEPROM (U1).
- ⑮ RGB LED (D4).
- ⑯ J1 LaunchPad Connector.
- ⑰ J1 Test Points.
- ⑱ Current Sense Amplifier (U4).
- ⑲ Current Sense Select Jumper (JP1).
- ⑳ Current Sense Disconnect Jumper (JP2).
- ㉑ 20-Pin DIP Socket + MSP430G2553 (U5).
- ㉒ SPI/I<sup>2</sup>C Test Points (J3).
- ㉓ J2 Test Points.
- ㉔ J2 LaunchPad Connector.
- ㉕ Optional Radio Reset Pushbutton Switch (S5).
- ㉖ Option Radio CC Debugger Header (J4).
- ㉗ Red LED (D8).
- ㉘ Yellow LED (D9).





## 2.1. Hardware Installation

### 2.1.1. AIR BoosterPack with MSP430 LaunchPad

The following steps need to be performed on each LaunchPad/BoosterPack:

- 1) If not already populated, solder both 10-pin male headers provided in the LaunchPad kit onto the LaunchPad’s J1 and J2 breakout connections.
- 2) Configure UART jumper settings on the LaunchPad.
  - a. For LaunchPad Rev1.4 and earlier, remove jumpers TXD and RXD from J3 and install crossover jumpers (not included) onto the same group of pins to make the following connections:
    - i. Connect J3.3 to J3.6
    - ii. Connect J3.5 to J3.4
  - b. For LaunchPad Rev1.5 and later, change the orientation of the J3 TXD and RXD jumpers to use the HW UART.
- 3) Ensure the VCC jumper is populated on J3. Jumpers RST and TEST also need to be installed when programming the microcontroller or when debugging software.
- 4) Remove the existing MSP430 device on the LaunchPad as the BoosterPack comes with a microcontroller already installed. Alternatively, the provided microcontroller may be installed in the LaunchPad’s socket. In either case, only one device should be installed at any given time. See Figure 4 and Figure 5 which show the two options for MSP430 location.
- 5) Install the AIR BoosterPack onto the LaunchPad board. Ensure the BoosterPack is oriented correctly. J1 of the BoosterPack must connect to J1 of the LaunchPad. The same is true for J2.

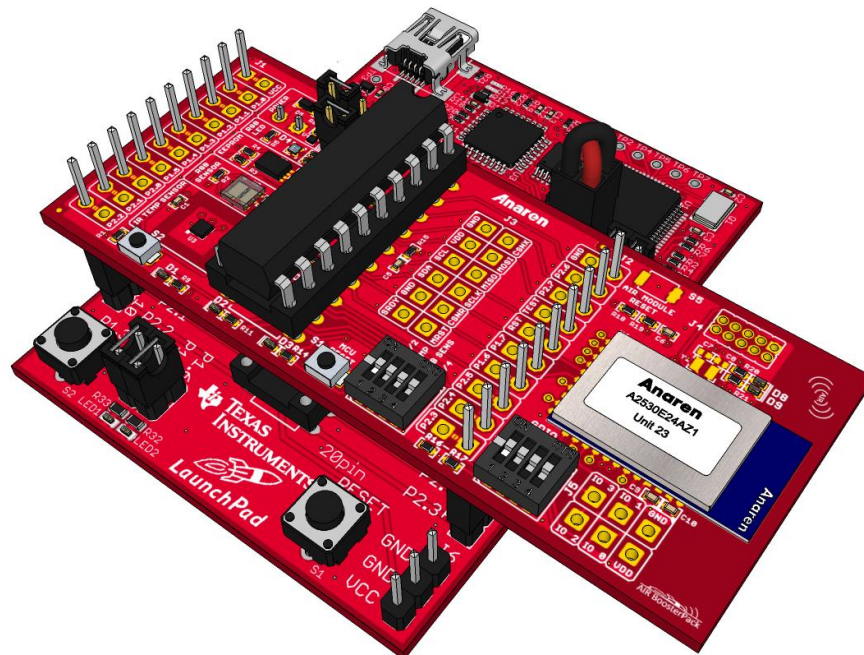


Figure 3 – Installed BoosterPack (MSP430 LaunchPad)



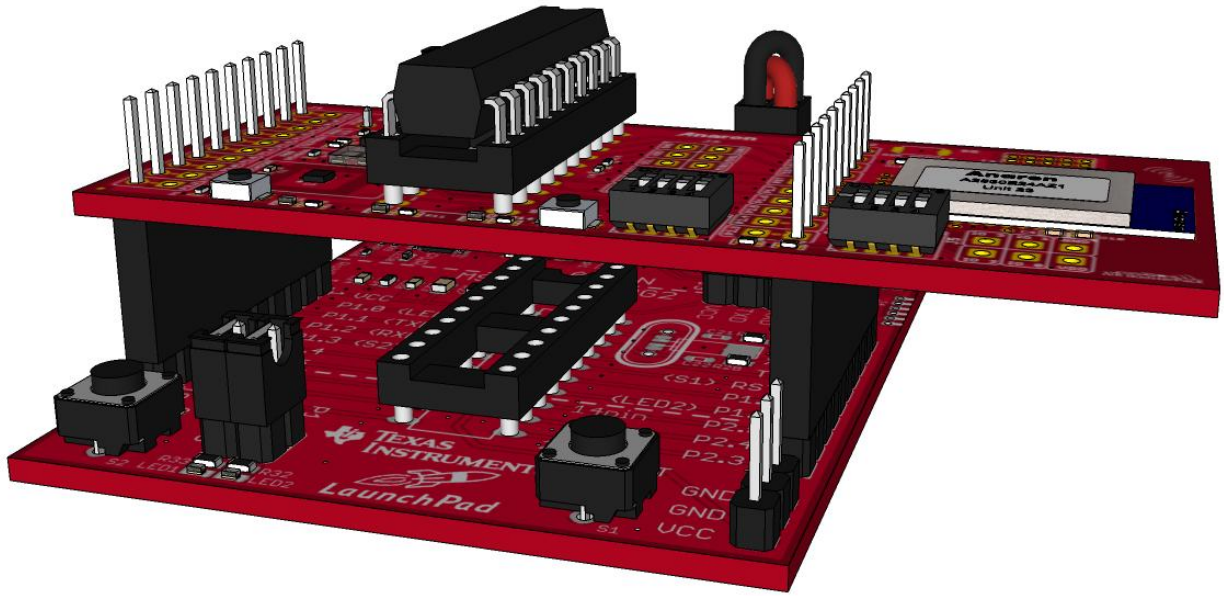


Figure 4 - Standard Installation (MSP430 on BoosterPack)

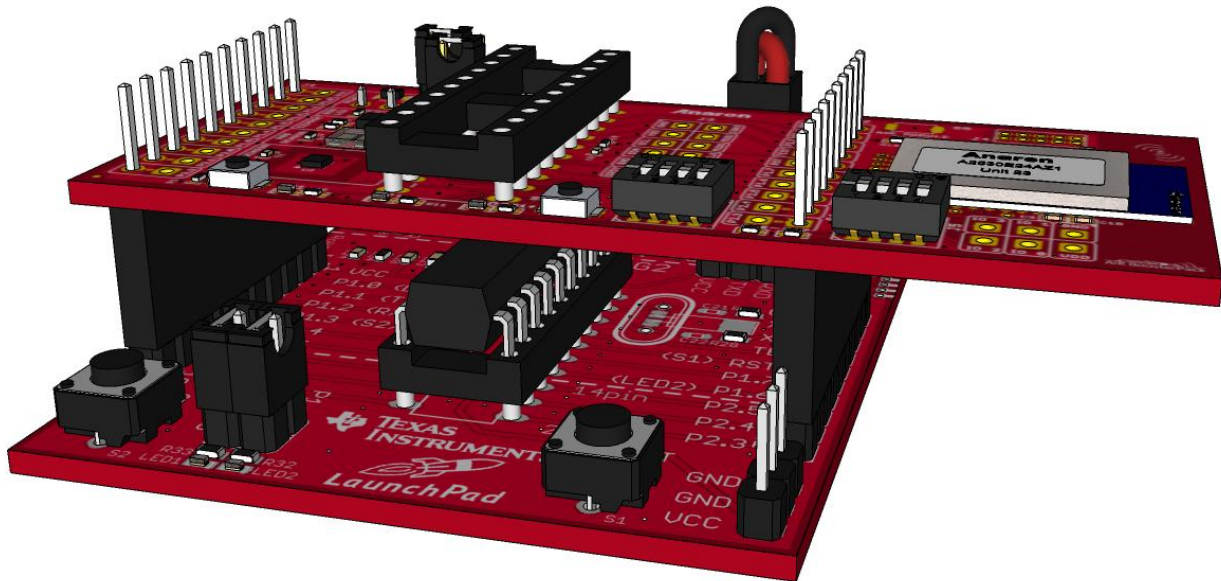


Figure 5 - Alternate Installation (MSP430 on LaunchPad)



## 2.1.2. AIR BoosterPack with Stellaris LaunchPad

The following steps need to be performed on each LaunchPad/BoosterPack:

- 1) Remove the provided MSP430 device on the BoosterPack.
- 2) Install the AIR BoosterPack onto the LaunchPad board. Ensure the BoosterPack is oriented correctly. J1 of the BoosterPack must connect to J1 of the LaunchPad. The same is true for J2.

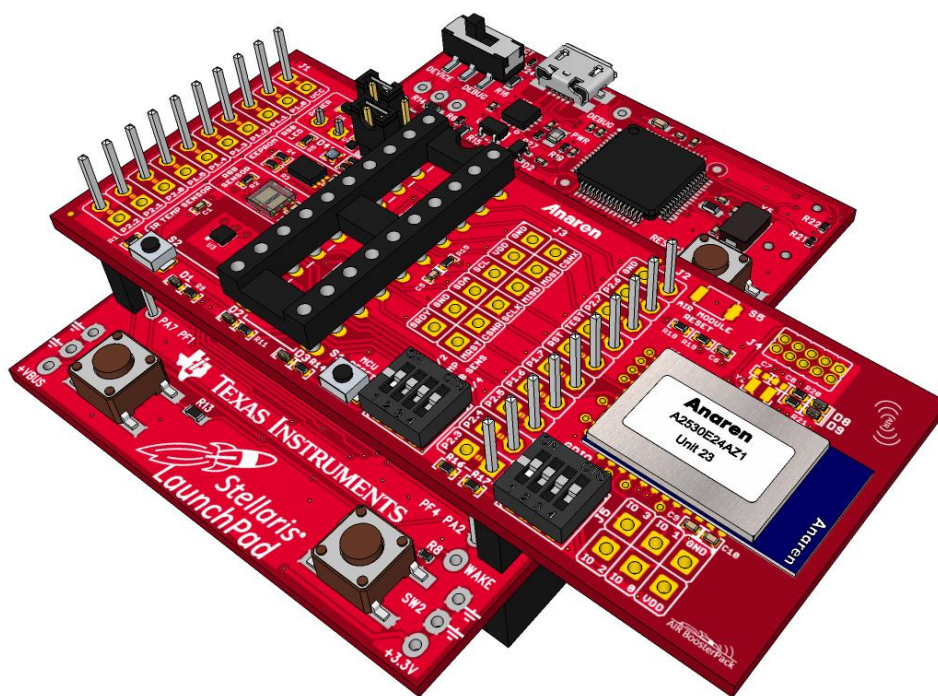


Figure 6 - Installed BoosterPack (Stellaris LaunchPad)

### Optional:

The default BoosterPack configuration utilizes a software I<sup>2</sup>C controller (i.e. bit-banded) to maintain compatibility with both LaunchPad types (i.e. MSP430 and Stellaris). Since the Stellaris microcontroller supports using UART, SPI, and I<sup>2</sup>C at the same time (compared to the MSP430G2553 which only has two USCIs), the BoosterPack may be configured to use the hardware I<sup>2</sup>C controller instead of the bit-banded controller. The following steps need to be performed on each LaunchPad/BoosterPack:

- 1) Install 10-pin connector (not included) at BoosterPack J1 Test Points location. This corresponds to the LaunchPad J3 connector (see Figure 7). The same can be done for BoosterPack J2 Test Points (LaunchPad J4), although this is optional. Only LaunchPad pins J3.3 and J3.4 are utilized by the BoosterPack. The remaining J3 and J4 LaunchPad signals are simply pass-thru.
- 2) Remove R9 and R10 from the LaunchPad. See Figure 8 for the location of these resistors.



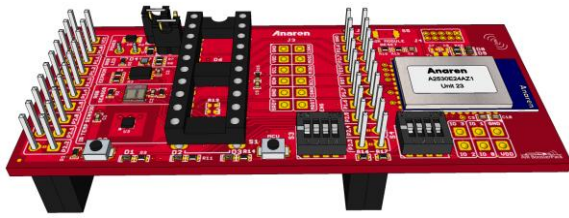


Figure 7 – BoosterPack with Additional Connectors Installed

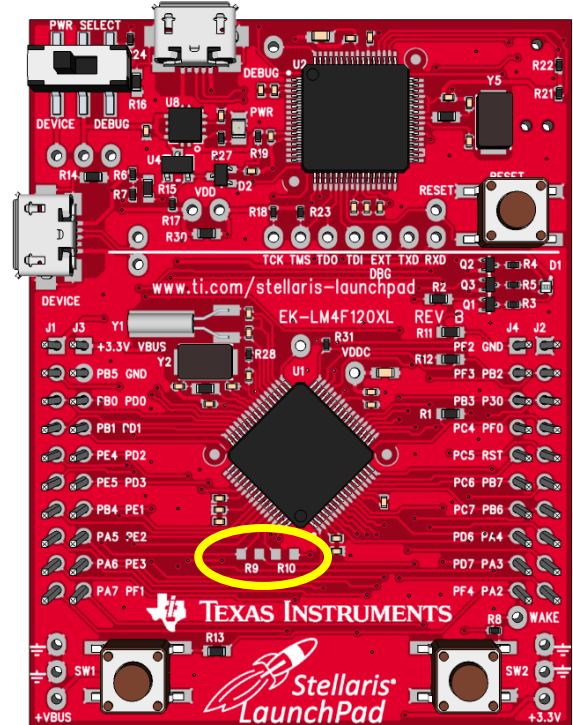


Figure 8 – Stellaris LaunchPad

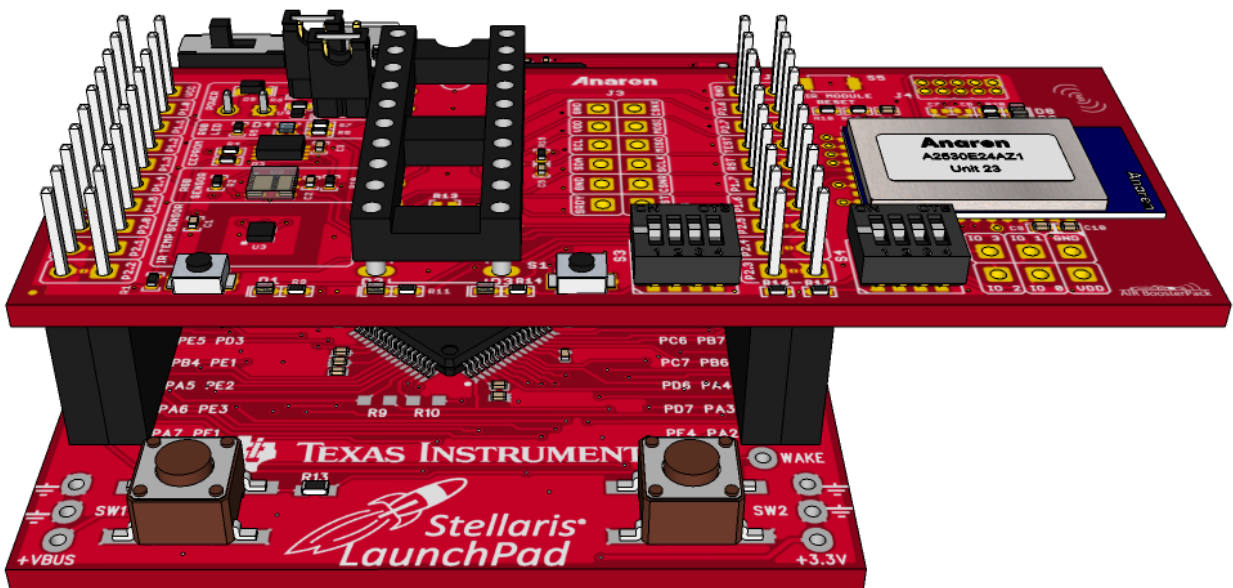


Figure 9 – Installed BoosterPack (with Additional Connectors, Stellaris LaunchPad)



## 2.2. USB Driver Installation

### System Requirements

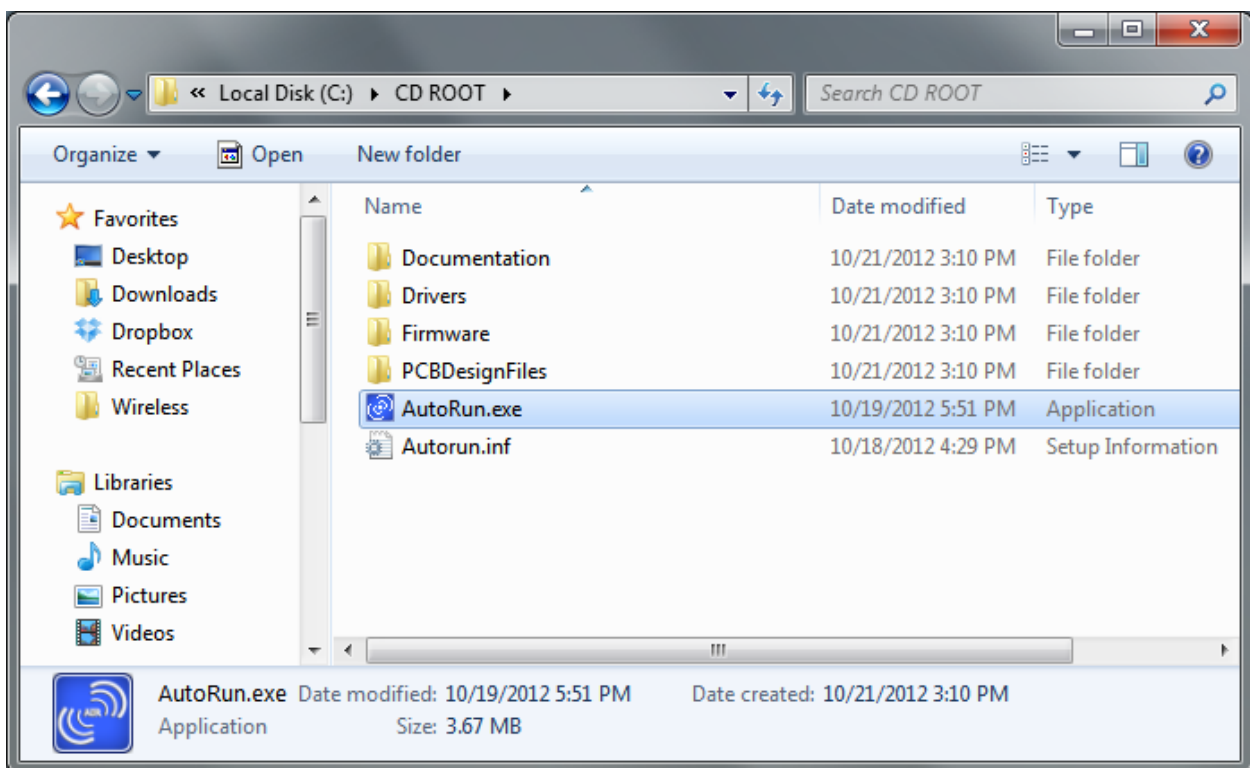
- Microsoft Windows XP SP3 or later operating system (32-bit and 64-bit supported)
- CD drive

Many of the provided firmware examples require using a Virtual COM port via the LaunchPad’s USB interface. If the necessary USB drivers have not already been installed on the PC/Laptop, follow one of the following procedures. Please note that the MSP430 and Stellaris LaunchPad boards each require different drivers.

- 1) Install drivers using the instructions provided with the LaunchPad kit.

– OR –

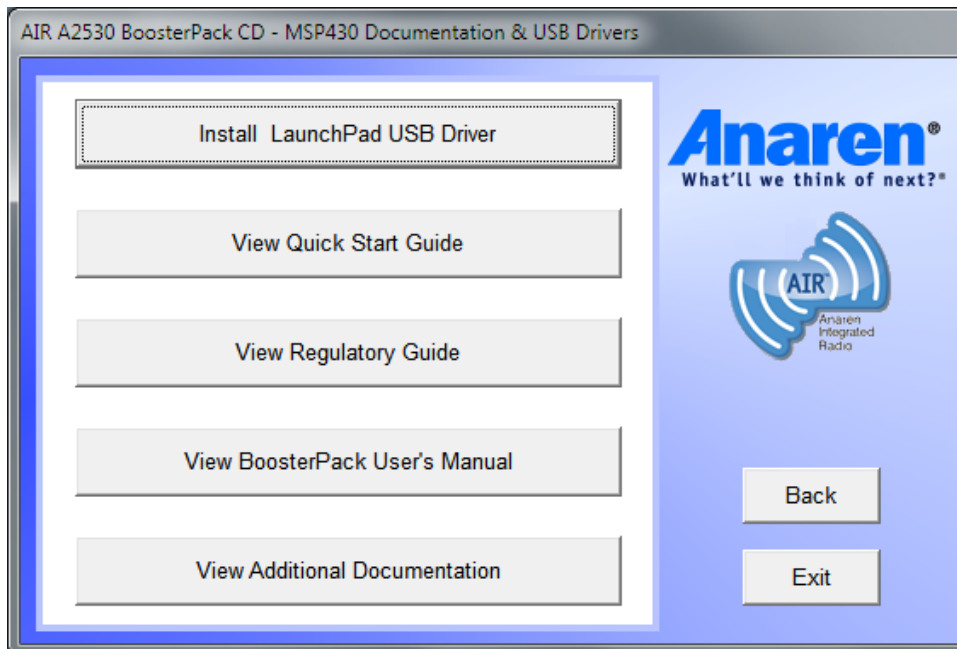
- 2) Install drivers provided on the CD in the A2530 BoosterPack kit following the steps below. These drivers are the same as those provided by TI; Anaren has simply provided a GUI to install them.
  - a. Insert the BooserPack CD in the CD drive. The AIR A2530 BoosterPack Installation GUI should automatically start. If it does not, navigate to the CD drive using Windows Explorer and then double click the AutoRun.exe icon.



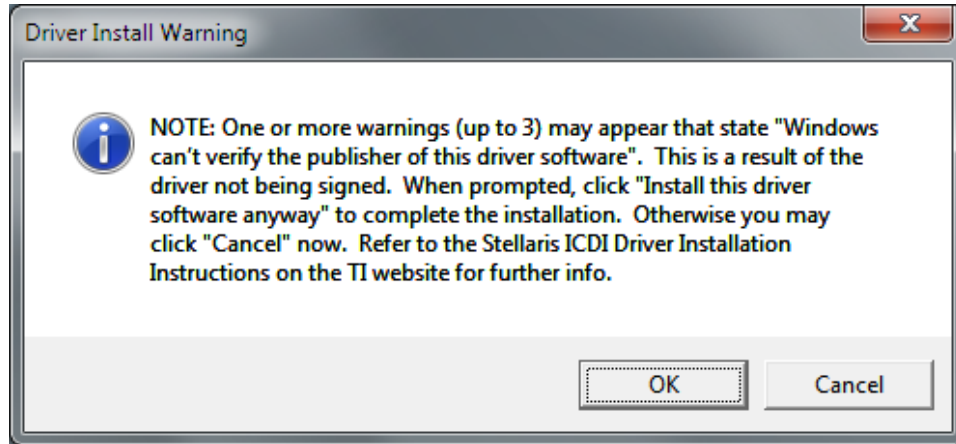
- b. Select which LaunchPad board will be used with the BoosterPack by clicking either the MSP430 button or Stellaris button.



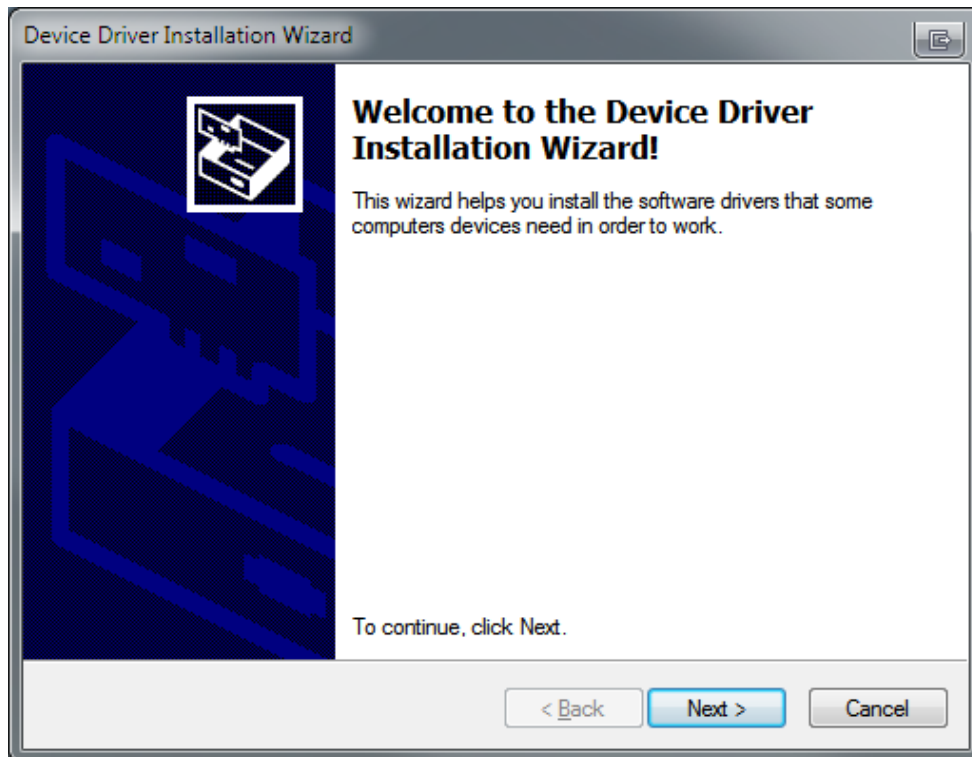
- c. Click on the “Install LaunchPad USB Driver” button.



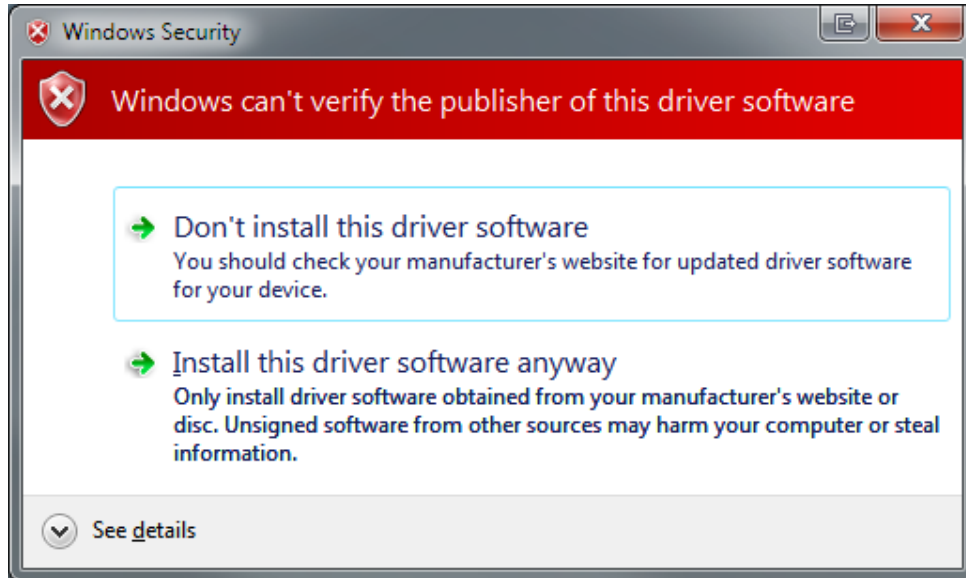
When installing Stellaris drivers, a message will pop up indicating that later steps may warn about drivers not being signed. The installation may be cancelled at this point if you do not want to install unsigned drivers, however the USB Virtual COM will be unusable. Click OK to continue with the installation if you agree with installing unsigned drivers.



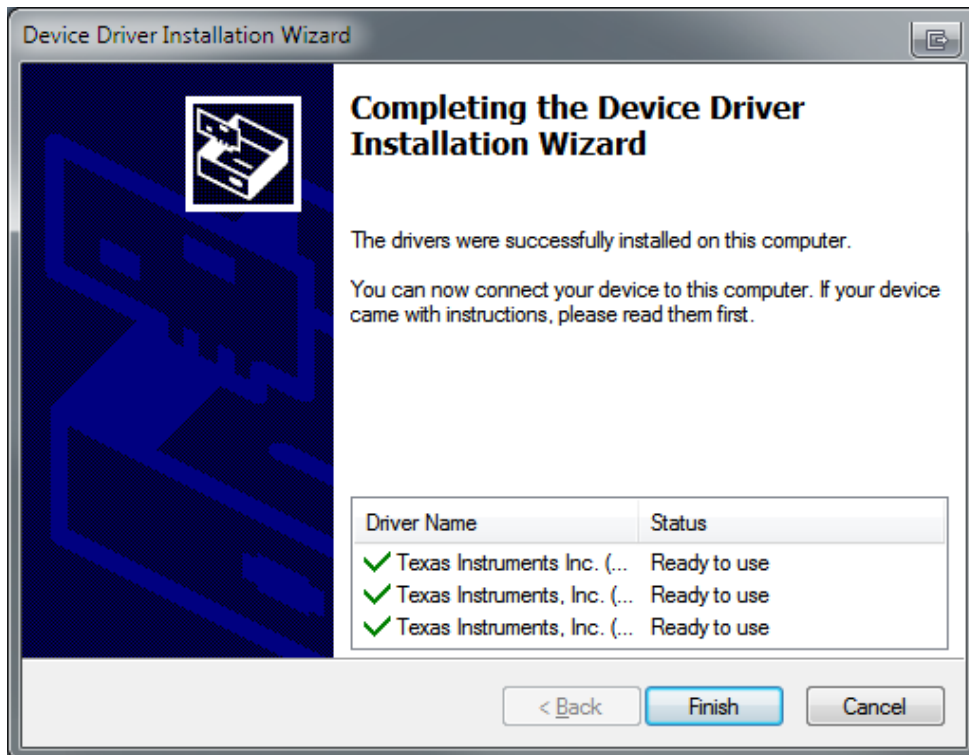
d. Click Next to continue the installation.



For Stellaris, Windows may provide a Security Warning due to the drivers not being signed. Click on “Install this driver software anyway” to continue installation. There may be up to three of these messages due to there being three separate drivers installed.



Click Finish when the installation is complete.

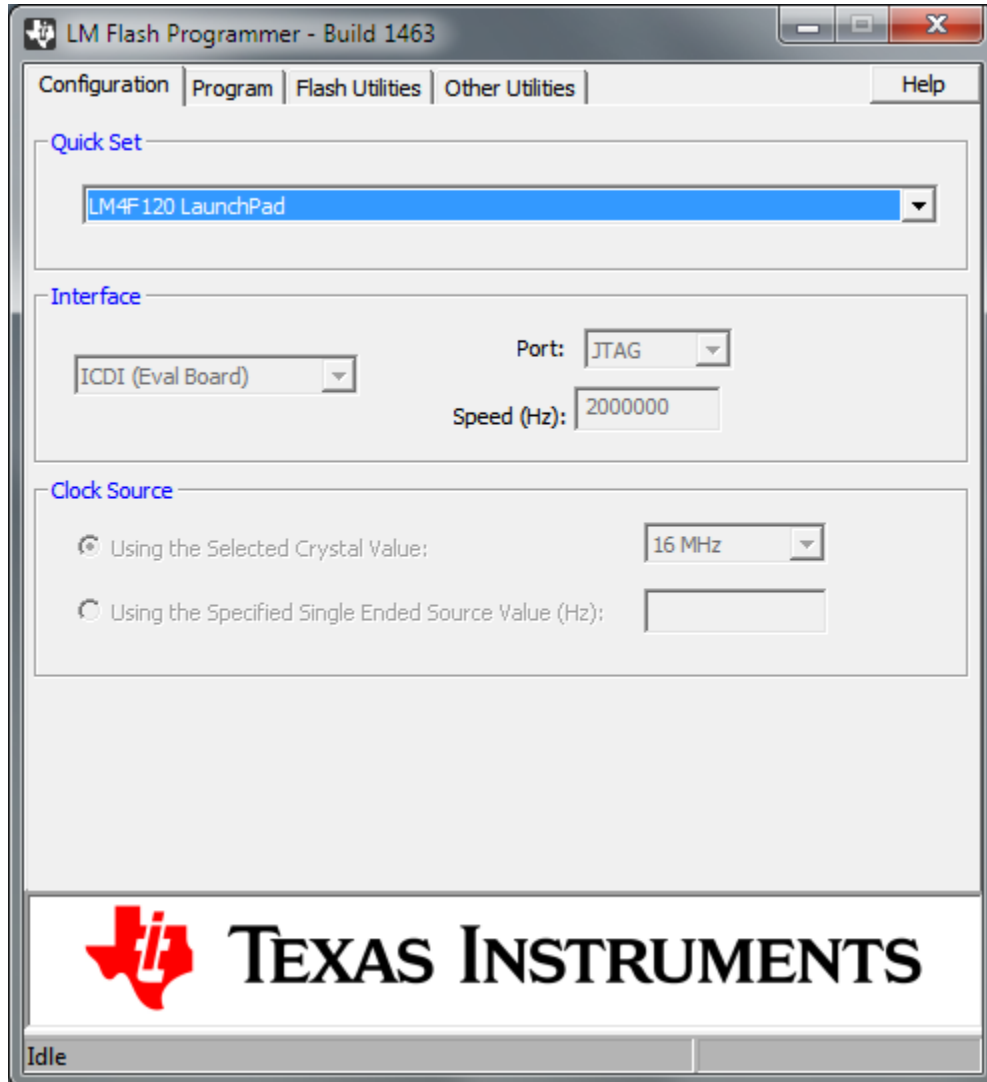




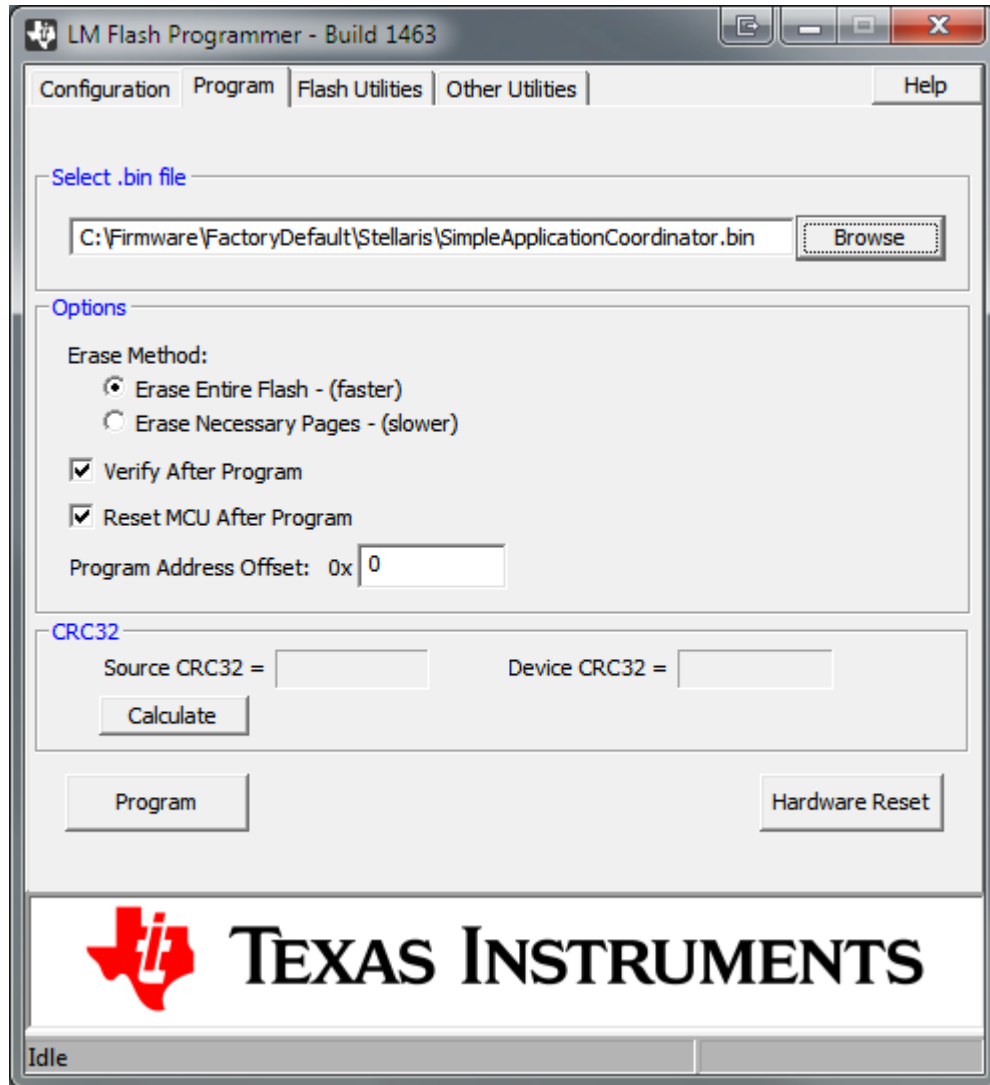
### 2.3. Programming the Demo Application on Stellaris

Follow these steps to load the “Simple Application” demo on each of the Stellaris LaunchPads.

- 1) Plug in one of the Stellaris LaunchPads to a USB port.
- 2) Run the Texas Instruments LM Flash Programmer utility available on the TI website.
- 3) In the Configuration tab, select “LM4F120 LaunchPad” from the Quick Set pull-down.



- 4) In the Program tab, browse to the “Firmware\FactoryDefault\Stellaris” folder on the BoosterPack CD and select “SimpleApplicationCoordinator.bin”. Then click Program.



- 5) Unplug the LaunchPad from the USB port.
- 6) Repeat steps 1 thru 5 above for the “SimpleApplicationRouter.bin” file.
- 7) Repeat steps 1 thru 5 above for the “SimpleApplicationEndDevice.bin” file.

Alternatively, the LaunchPads may be programmed using Code Composer Studio (CCS). The CCS projects are located in the “Firmware\ ZM Examples\CCS\_Stellaris” folder on the BoosterPack CD.

Continue to section 2.4 for information on using the demo application.



## 2.4. IMPORTANT: Required Radio Setup

The AIR BoosterPack must be operated in accordance with local regulations. The firmware preloaded in the MSP430G2553 devices provided with the AIR BoosterPack kit (or loaded into the Stellaris devices as described in section 2.3) offers two radio operation options; FCC/IC for use in US/Canada (default) and ETSI for use in Europe. If your location is not covered by either FCC/IC or ETSI then you must check local regulatory codes for how to obtain permission to operate the modules prior to using them.

If covered under ETSI regulations, you must first change S4-1 to the OFF position as shown in Figure 10.

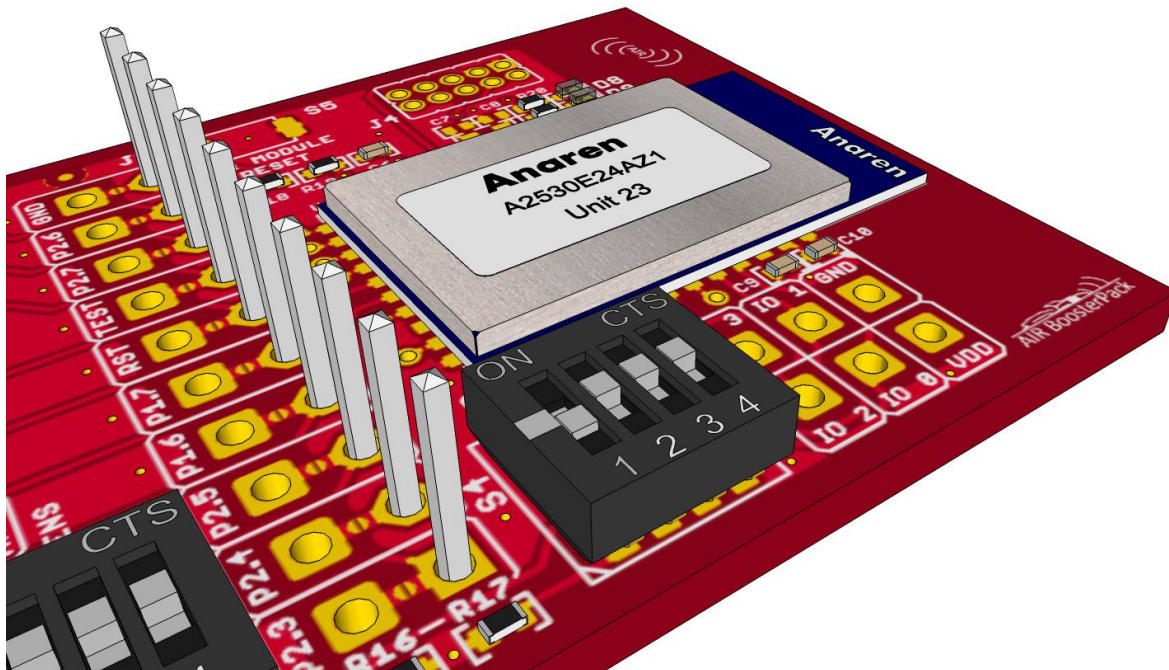


Figure 10 –BoosterPack Configured For Use in Europe (ETSI)



## 2.5. Using the Demo Application

The “Simple Application” demo is an example sensor network that passes measured data from the Router(s) and/or End Point(s) to the Coordinator.

All nodes configured as a Router periodically (about every 1.5 seconds) read the onboard IR Temperature sensor and transmit the value to the Coordinator. To change the sensor readings, simply place a warm (e.g. palm of your hand) or cold (e.g. soda can) object a few inches from the sensor. There is no need to have physical contact between the sensor and the object.

Similarly, all nodes configured as an End Point periodically (about every 3 seconds) read the onboard RGB Light sensor and transmit the value to the Coordinator. To change the sensor readings, shine a different color light at the sensor.

After applying power to the nodes they should start communicating within a minute. When communicating, each node blinks an LED.

- Coordinator flashes red LED D1
- Router RGB LED normally green, flashes blue
- End Point RGB LED normally OFF, flashes blue

The Coordinator displays the received data from the Router(s) and End Point(s) in two ways.

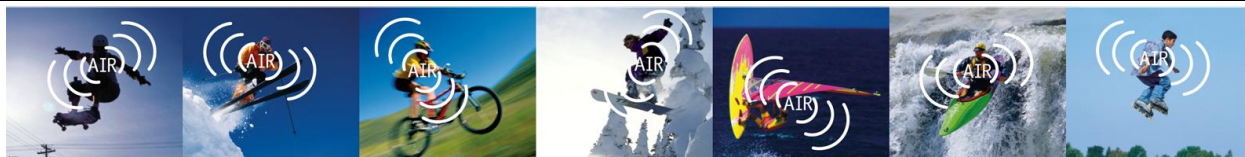
- 1) The data is sent out the UART. All messages received are displayed with details of the data transfer in addition to the actual measurements. The information may be viewed on a terminal emulator connected to the LaunchPad USB Virtual COM port. The port must be configured as 9600,8,N,1 for MSP430 and 115200,8,N,1 for Stellaris.
- 2) The measurements are displayed graphically via the onboard RGB LED (BoosterPack LED for MSP430, LaunchPad LED for Stellaris).
  - a. Router IR Temperature values are displayed as follows:
    - Blue = Cold
    - Green = Warm (room)
    - Red = Hot

To select this mode, press the S2 pushbutton (SW1 on the Stellaris LaunchPad) one time on the Coordinator. Red LED D8 should be OFF and yellow LED D9 should be ON.

- b. The color of light detected by the EndPoint RGB Light Sensor is displayed. To select this mode, press the S2 pushbutton (SW1 on the Stellaris LaunchPad) a second time on the Coordinator. Red LED D8 should be ON and yellow LED D9 should be OFF.

## 2.6. AIR A2530 Wiki

Please visit the AIR A2530 Wiki (<http://www.anaren.com/air-wiki-zigbee>) on the Anaren website for details regarding the example applications, Module Interface Specification (i.e. API), and general Zigbee® information.

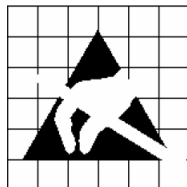


## 3. AIR BoosterPack Hardware

### 3.1. Electrical Characteristics

#### 3.1.1. Absolute Maximum Ratings

Under no circumstances shall the absolute maximum ratings given in Table 2 be violated. Stress exceeding one or more of the limiting values may cause permanent damage to the device.



**Caution!**  
 ESD sensitive device. Precaution should be used when handling the device in order to prevent permanent damage.

*Table 2 - Absolute Maximum Ratings*

Parameter	Min	Max	Unit	Condition
Supply Voltage	-0.3	3.8	V	
Voltage On Any Digital Pin	-0.3	VDD + 0.3 max 3.8	V	
Input RF Level		+10	dBm	
Storage Temperature Range	-40	85	°C	
ESD		<2000	V	According to JEDEC STD 22, method A114, Human Body Model (HBM)
		<500	V	According to JEDEC STD 22, C101C, Charged Device Model (CDM)

#### 3.1.2. Recommended Operating Conditions

*Table 3 - Recommended Operating Conditions*

Parameter	Min	Max	Unit	Condition
Operating Supply Voltage	2.7	3.6	V	RGB Light Sensor powered
	2.2	3.6	V	RGB Light Sensor disconnected
Operating Temperature	-40	85	°C	



### 3.2. Functional Description

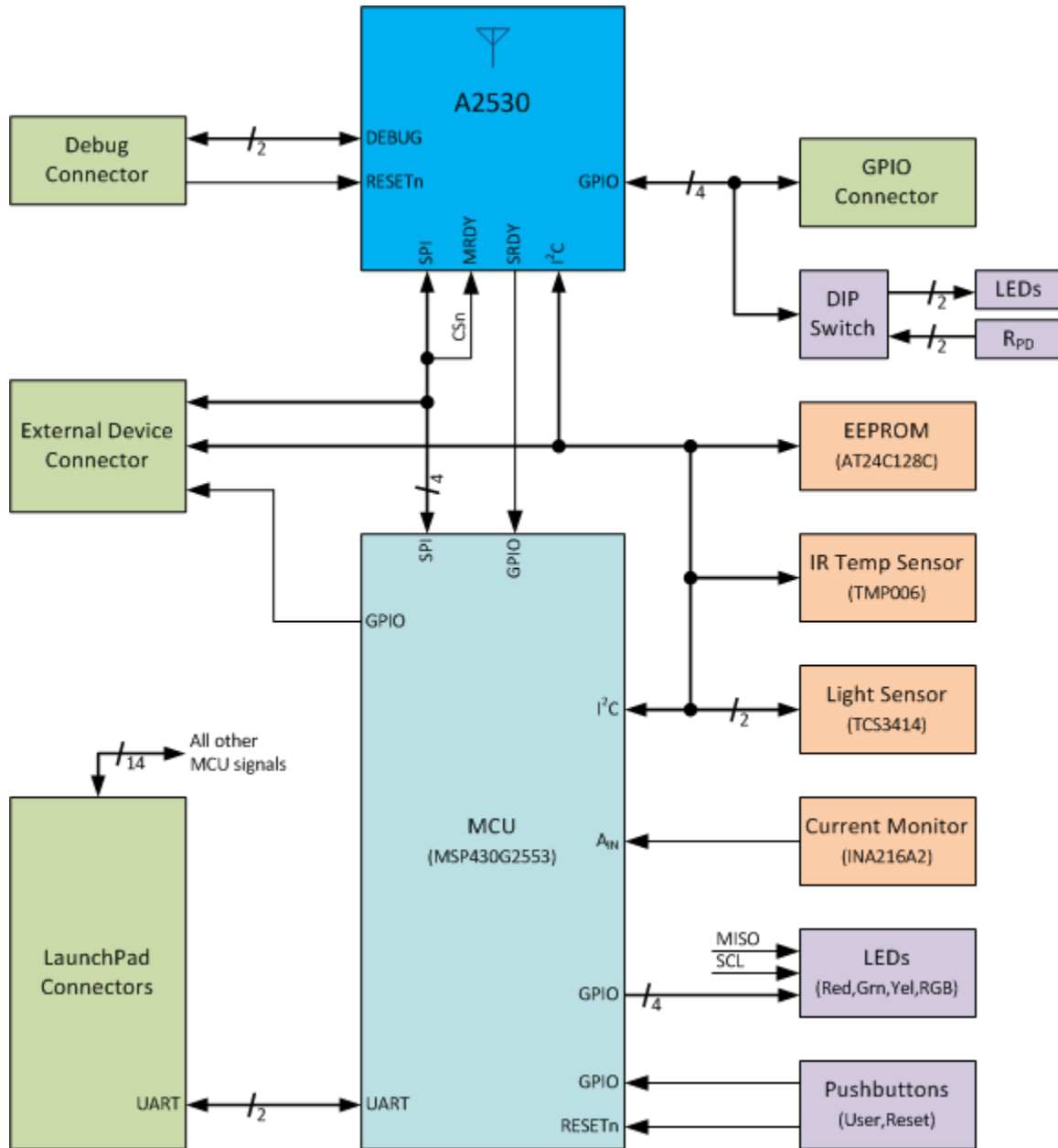


Figure 11 – Hardware Block Diagram



### 3.2.1. A2530 Radio Module (U6)

The Anaren A2530 module is a 2.4GHz IEEE 802.15.4 compliant radio running the Texas Instruments ZNP protocol. For details regarding the radio module, refer to the A2530E24x and A2530R24x User’s Manuals located on the CD provided in the BoosterPack kit.

### 3.2.2. MCU & Socket (U5)

The BoosterPack has a 20-pin DIP socket with a MSP430G2553 MCU pre-installed. This allows for operation of the BoosterPack while installed on a LaunchPad board or standalone. Please refer to the MSP430G2x53 datasheet and MSP430x2xx Family User’s Guide on the TI website for further info regarding this device.

### 3.2.3. Sensors

- **RGB Light Sensor (U2)**

The TAOS TCS3414 Digital Color Sensor ( $I^2C$ ) measures the color of ambient light and reports the measurements in 16-bit RGBC (Red/Green/Blue/Clear) format. Please refer to the TCS3414 datasheet on the TAOS website for further info regarding this device.

The  $I^2C$  bus address of this device is 0x39.

- **IR Temperature Sensor (U3)**

The Texas Instruments TMP006 Infrared Thermopile Sensor ( $I^2C$ ) measures the temperature of an object without the need to make contact with the object (-40C to +125C operating range). Please refer to the TMP006 datasheet on the TI website for further info regarding this device.

Please note the BoosterPack itself is rated to +85C and should not be subjected to ambient temperatures above this limit.

The  $I^2C$  bus address of this device is 0x40.

- **Current Sensor (U4)**

The Texas Instruments INA216A2 Current Shunt Monitor (analog) amplifies the voltage across a current sense resistor with a gain of 50. Please refer to the INA216 datasheet on the TI website for further info regarding this device.

The sensor’s analog output is routed to MSP430 pin P1.4 where it can be sampled using the MCU’s internal ADC. The measured voltage can be used to calculate the current draw of the A2530 only or that of the entire board. The selection is made by setting jumper JP1 to the desired position (see section 3.2.7 for information on setting the jumper). To calculate current flowing through the 0.2 $\Omega$  sense resistor, simply divide the measured voltage by 10 ( $I_{shunt} = V_{shunt} / R_{shunt}$ , where  $R_{shunt} = 0.2\Omega$  and  $V_{shunt} = V_{meas} / 50$ ).



### 3.2.4. Serial EEPROM (U1)

A 128Kbit (16K x 8) serial EEPROM is provided for applications that require storing data in nonvolatile memory. Please refer to the AT24C128C datasheet on the Atmel website for further info regarding this device.

The I<sup>2</sup>C bus address of this device is 0x50.

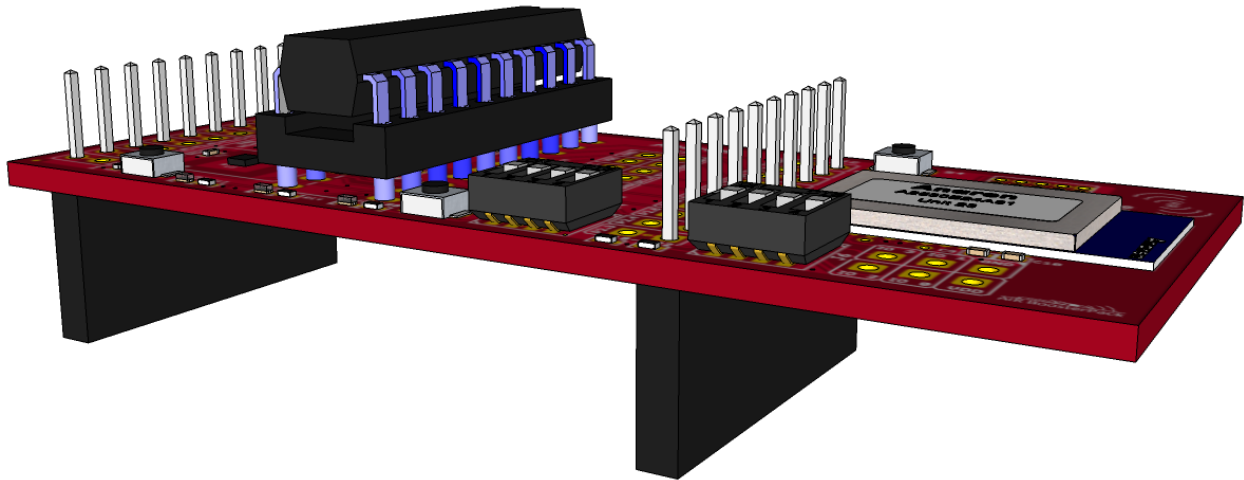
### 3.2.5. LED Indicators

- **Red LED (D1)**  
Duplicate of Red LED on MSP430 LaunchPad. Controlled by MSP430 P1.0 (J1.2) – active high.
- **Green LED (D2)**  
Duplicate of Green LED on MSP430 LaunchPad. Controlled by MSP430 P1.6 (J2.4) – active high. This LED is shared with the SPI MISO signal and is therefore unusable without modification to the SPI driver.
- **Yellow LED (D3)**  
Controlled by MSP430 P2.4 (J2.2) – active low. This LED is shared with the I<sup>2</sup>C SCL signal and is only usable when not using I<sup>2</sup>C.
- **Tri-Color LED (D4)**  
When using a MSP430 the Tri-Color LED can be pulse width modulated (PWM) to produce a wide range of colors. This capability is not available when the BoosterPack is used with a Stellaris LaunchPad due to lack of PWM capability on the chosen pins. In this situation, the Tri-Color LED on the Stellaris LaunchPad will need to be used instead for applications requiring multiple colors. The BoosterPack Tri-Color LED is controlled as follows:
  - Red Segment – MSP430 P2.1/TA1.1 (J1.9) – active low.
  - Green Segment – MSP430 P2.5/TA1.2 (J2.3) – active low.
  - Blue Segment – MSP430 P2.6/TA0.1 (J2.9) – active low.
- **A2530 Red LED (D8)**  
Controlled by A2530 P1.0 (GPIO3) – active high.
- **A2530 Yellow LED (D9)**  
Controlled by A2530 P0.6 (GPIO2) – active high.





- **Blue LEDs (D6, D7)**  
These LEDs (when populated) are always ON and are intended to produce a “cool” looking visual effect which is especially noticeable when the BoosterPacks are operated in a dark environment.



*Figure 12 – BoosterPack with Blue LEDs Installed*

### 3.2.6. Switches

- **MCU Reset (S1)**  
Duplicate of S1 reset pushbutton on MSP430 LaunchPad. Active low.
- **MCU Control Input (S2)**  
Duplicate of S2 user pushbutton on MSP430 LaunchPad. Active low.
- **A2530 Reset (S5)**  
Radio Module hardware reset. Active low.



▪ **Sensor/LED Power Control (S3)**

These DIP switches are used to control power to specific devices on the BoosterPack board. The primary purpose is to provide a method for turning off unused devices to conserve power. For example, an application not using the Color Light Sensor would benefit from turning off position 3, since the light sensor is relatively power hungry. Another example would be an application that utilizes the LEDs but the user turns off positions 1 and 4 to reduce power consumption (no code change necessary).

The default state of all DIP switches is ON (closed).

*Table 4 – Sensor/LED DIP Switch Settings (S3)*

Switch	Position	Signal Name	Description
S3	1	D1,2_EN	Power control for the on-board Red and Green LEDs (D1 and D2, respectively). Does not impact LEDs on the LaunchPad boards.  ON (closed): Red and Green LEDs are enabled and may be turned on by driving their control signals high.  OFF (open): Red and Green LEDs are disabled and cannot be turned on, regardless of the state of their control signals.
	2	TEMP/ROM_EN	Power control for the IR Temperature Sensor and EEPROM on the I <sup>2</sup> C bus.  ON (closed): Power is applied to these devices.  OFF (open): The devices are powered down.
	3	LGT_EN	Power control for the I <sup>2</sup> C RGB Light Sensor.  ON (closed): Power is applied to the device.  OFF (open): The device is powered down.
	4	D3,4_EN	Power control for the on-board Yellow and Tri-Color LEDs (D3 and D4, respectively). Does not impact LEDs on the LaunchPad boards.  ON (closed): Yellow and Tri-Color LEDs are enabled and may be turned on by driving their control signals low.  OFF (open): Yellow and Tri-Color LEDs are disabled and cannot be turned on, regardless of the state of their control signals.



▪ **Radio Module GPIO (S4)**

These DIP switches are used to electrically isolate the LEDs and pull-down resistors from the A2530 GPIO signals for applications that require the GPIO but don’t want the added load of the resistors and LEDs. Positions 1 and 2 (GPIO0 and GPIO1, respectively) may also be used as user input.

The default state of all DIP switches is ON (closed).

*Table 5 – Radio Module GPIO DIP Switch Settings (S4)*

Switch	Position	Signal Name	Description
S4	1	GPIO0	Provides a method for changing the state of the A2530 GPIO input.  ON (closed): Signal is pulled to GND through a 2KΩ Ohm resistor.  OFF (open): Signal is floating.
	2	GPIO1	Provides a method for changing the state of the A2530 GPIO input.  ON (closed): Signal is pulled to GND through a 2KΩ Ohm resistor.  OFF (open): Signal is floating.
	3	GPIO2	A2530 Yellow LED connect/disconnect.  ON (closed): Yellow LED is enabled and may be turned on by driving its control signal high.  OFF (open): Yellow LED is disabled and cannot be turned on, regardless of the state of its control signal.
	4	GPIO3	A2530 Red LED connect/disconnect.  ON (closed): Red LED is enabled and may be turned on by driving its control signal high.  OFF (open): Red LED is disabled and cannot be turned on, regardless of the state of its control signal.



### 3.2.7. Jumpers

- **Current Sensor**

The onboard Current Sensor can be configured to measure the current drawn by the A2530 radio module only or by the entire board. The current consumption of the radio module is always measured and the installed shunt determines which side of the current sense resistor the remainder of the board gets its power from. Therefore there must always be a shunt installed on JP1, otherwise only the radio module will be powered.

For applications that do not require current sensing and wish to utilize the MCU pin for another function, the Current Sensor’s analog output can be disconnected from the rest of the board by removing the shunt from JP2.

*Table 6 - JP1 Jumper Settings (Current Sensor Select)*

Jumper	Position	Description
JP1	1	Current Sensor measures radio module only (default)
	2	Current Sensor measures entire board

*Table 7 - JP2 Jumper Settings (Current Sensor Enable)*

Jumper	Position	Description
JP2	Closed	Current Sensor analog output connected to MCU (default)
	Open	Current Sensor analog output disconnected from MCU

- **Radio Module Configuration**

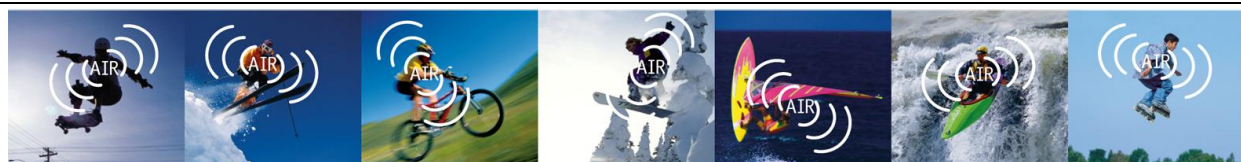
JP100 and JP101 control the operating mode of the A2530 radio module. Currently JP100 is reserved for future use while JP101 selects whether the electrical interface to the module is SPI or UART. Both of these are 3-terminal jumpers that can accommodate a 0603 resistor populated in one of two positions. The BoosterPack is shipped with a PCB trace making the default connection. To change to a different setting, this trace must be cut prior to soldering a resistor in the new position.

*Table 8 - JP100 Jumper Settings (CFG0)*

Jumper	Position	Radio Signal Name	Description
JP100	1	CFG0	Reserved (default)
	2		Reserved

*Table 9 - JP101 Jumper Settings (CFG1)*

Jumper	Position	Radio Signal Name	Description
JP101	1	CFG1	Radio uses SPI interface (default)
	2		Radio uses UART interface



▪ **Radio Module Pin Mapping**

The AIR BoosterPack board provides the ability to remap several of the radio module’s I/O pins to different MCU pins. JP102, JP105, and JP108 consist of one or more 0603 SMT pads which allow a zero Ohm resistor to be soldered in place to select the desired jumper position. The default signal routing is determined by a small trace between one set of pads. To change jumper positions, this trace needs to be cut and a zero Ohm resistor soldered in the new position.

JP102, in conjunction with R100, selects whether the radio module’s reset signal is generated by MCU pin P2.5 or P2.7. This allows applications requiring a crystal on the MCU to use a different pin for radio module reset, at the expense of giving up the use of the Green segment of the Tri-Color LED.

SRDY is a required signal when using a secondary MCU with the A2530 radio module, there JP105 should not be modified.

JP108 can be used to select whether MRDY is tied to MODULE\_SS or uses its own MCU pin. Some applications may require MRDY to be isolated from MODULE\_SS. In these cases, MRDY can be configured to use MCU pin P1.4 instead of P2.0, at the expense of giving up the use of the Current Sensor.

*Table 10 – JP102 Jumper Settings*

Jumper	Position	Radio Signal Name	MCU Signal Name	Description
JP102	Closed	MRST	P2.7	MRST connected to MCU pin P2.7 (default)
	Open		/MRST	MRST disconnected from MCU pin P2.7

*Table 11 – JP105 Jumper Settings*

Jumper	Position	Radio Signal Name	MCU Signal Name	Description
JP105	Closed	SRDY	P2.2/	SRDY connected to MCU pin P2.2 (default)
	Open		SRDY	SRDY disconnected from MCU pin P2.2

*Table 12 – JP108 Jumper Settings*

Jumper	Position	Radio Signal Name	MCU Signal Name	Description
JP108	1	MRDY	P2.0/ MODULE_SS	MRDY connected to MCU pin P2.0 (default)
	2		P1.4/ CUR/ MRDY/ EXT_CSN	MRDY connected to MCU pin P1.4



- **I<sup>2</sup>C Pin Mapping**

The example application preloaded in the MSP430 uses a software I<sup>2</sup>C controller on port pins P2.3 and P2.4. For Stellaris applications utilizing a hardware I<sup>2</sup>C controller, JP106 and JP107 may be used to free up these two pins for other purposes. Both of these are 2-terminal jumpers that can accommodate a 0603 resistor. The BoosterPack is shipped with a PCB trace making the connection by default. To break the connection, this trace must be cut.

*Table 13 - JP106 Jumper Settings (SDA)*

Jumper	Position	LaunchPad Signal Name	MSP430 Signal Name	Description
JP106	Closed	P2.3/ SDA	SDA	MSP430 P2.3 connected to J2-1 (default)
	Open			MSP430 P2.3 disconnected from J2-1

*Table 14 - JP107 Jumper Settings (SCL)*

Jumper	Position	LaunchPad Signal Name	MSP430 Signal Name	Description
JP107	Closed	P2.4/ SCL/ LED3	SCL	MSP430 P2.4 connected to J2-2 (default)
	Open			MSP430 P2.4 disconnected from J2-2

- **Miscellaneous**

JP103 and JP104 are small solder jumpers intended for test purposes only. Do not bridge the gap at these locations as the I<sup>2</sup>C signals (SCL, SDA) would be shorted directly to GND, preventing normal operation of the I<sup>2</sup>C bus.

*Table 15 - JP103 Jumper Settings*

Jumper	Position	Radio Signal Name	MCU Signal Name	Description
JP103	Closed	TP23	SDA	Reserved
	Open			Reserved (default)

*Table 16 - JP104 Jumper Settings*

Jumper	Position	Radio Signal Name	MCU Signal Name	Description
JP104	Closed	TP21	SCL	Reserved
	Open			Reserved (default)



### 3.2.8. Connectors

- **J1 – LaunchPad J1 Interface**

*Table 17 – J1 LaunchPad Connector Pinout*

Pin	Signal Name	I/O	Description
J1-1	LP_VCC	I	Supply voltage
J1-2	P1.0/LED1	O	LaunchPad Red LED Control – active high (onboard MSP430)
		I	Red LED control – active high (external LaunchPad MCU)
J1-3	P1.1/RXD	I	UART receive data (onboard MSP430)
		-	Not Connected (external LaunchPad MCU)
J1-4	P1.2/TXD	O	UART transmit data (onboard MSP430)
		-	Not Connected (external LaunchPad MCU)
J1-5	P1.3/S2	I/O	Pushbutton Switch connected in parallel with S2 on MSP430 LaunchPad – active low
J1-6	P1.4/CUR/MRDY/EXT_CS	O	Not Used (onboard MSP430)
		O	Current Sensor analog signal (external LaunchPad MCU)
J1-7	P1.5/SCLK	O	Not used (onboard MSP430)
		I	Radio Module SPI Clock (external LaunchPad MCU)
J1-8	P2.0/MODULE_SS	O	Not Used (onboard MSP430)
		I	Radio Module Slave Select - active low (external LaunchPad MCU)
J1-9	P2.1/LED4	O	Not Used (onboard MSP430)
		I	RGB red LED control – active low (external LaunchPad MCU)
J1-10	P2.2/SRDY	O	Not Used (onboard MSP430)
		O	Radio Module Slave Ready – active high (external LaunchPad MCU)



- **J2 – LaunchPad J2 Interface**

*Table 18 - J2 LaunchPad Connector Pinout*

Pin	Signal Name	I/O	Description
J2-1	P2.3/SDA	I/O	Not used (onboard MSP430)
			I <sup>2</sup> C Data (external LaunchPad MCU)
J2-2	P2.4/SCL/LEDS	O	I <sup>2</sup> C Clock output (onboard MSP430)
		I	I <sup>2</sup> C Clock input (external LaunchPad MCU)
J2-3	P2.5/LED5	O	Not Used (onboard MSP430)
		I	RGB green LED control – active low (external LaunchPad MCU)
J2-4	P1.6/MISO/LED2	O	LaunchPad Green LED Control – active high (onboard MSP430)
		O	Radio Module SPI Data Output (external LaunchPad MCU)
		I	Green LED control – active high (external LaunchPad MCU)
J2-5	P1.7/MOSI	O	SPI MOSI (onboard MSP430)
		I	Radio Module SPI Data Input (external LaunchPad MCU)
J2-6	RST/S1	I/O	Reset / Spy-Bi-Wire Data (onboard MSP430)
		-	Not Connected (external LaunchPad MCU)
J2-7	TEST	I	Test / Spy-Bi-Wire Clock (onboard MSP430)
		-	Not Connected (external LaunchPad MCU)
J2-8	P2.7/MRST	O	Not Used (onboard MSP430)
		I	Radio Module Reset – active low (external LaunchPad MCU)
J2-9	P2.6/LED6	O	Not Used (onboard MSP430)
		I	RGB blue LED control – active low (external LaunchPad MCU)
J2-10	GND	-	Ground reference





▪ **J3 – External Device Interface**

0.1” pitch thru-hole footprint which provides a single location for connecting external devices (e.g. sensors) to the BoosterPack via SPI and/or I<sup>2</sup>C.

It is also possible to connect an external MCU acting as SPI/I<sup>2</sup>C master to this port, provided the LaunchPad/BoosterPack MCU is removed or configured as SPI/I<sup>2</sup>C slave device (e.g. to drive LEDs or monitor pushbuttons). Firmware examples for using the LaunchPad/BoosterPack MCU as a slave device are not provided.

Please note that the shunt must be removed from JP2 when using an external SPI slave device (see section □ for more details).

*Table 19 – J3 External Device Connector Pinout*

Pin	Signal Name	I/O	Description
J3-1	GND	-	Ground reference
J3-2	P1.4/CUR/MRDY/EXT_CS	O	Chip Select output to external SPI slave – active low
J3-3	VDD	O	Supply voltage to external device(s)
J3-4	P1.7/MOSI	O	MOSI output to external SPI slave (MCU on LaunchPad or BoosterPack)
		I	MOSI input from external SPI master (external MCU connected via J3)
J3-5	SCL	O	Clock output to external I <sup>2</sup> C slave(s) (MCU on LaunchPad or BoosterPack)
		I	Clock input from external I <sup>2</sup> C master (external MCU connected via J3)
J3-6	P1.6/MISO/LED2	O	MISO output to external SPI master (external MCU connected via J3)
		I	MISO input from external SPI slave (MCU on LaunchPad or BoosterPack)
J3-7	SDA	I/O	I <sup>2</sup> C Data
J3-8	P1.5/SCLK	O	SCLK output to external SPI slave (MCU on LaunchPad or BoosterPack)
		I	SCLK input from external SPI master (external MCU connected via J3)
J3-9	GND	-	Ground reference
J3-10	P2.0/MODULE_SS	O	Not Used (MCU on LaunchPad or BoosterPack)
		I	Radio Module Chip Select input from external SPI master (external MCU connected via J3)
J3-11	SRDY	O	Radio Module Slave Ready output
J3-12	MRST	O	Not Used (MCU on LaunchPad or BoosterPack)
		I	Radio Module hardware reset – active low (external MCU connected via J3)



- **J4 – Radio Module Programming/Debugging Interface**  
0.05” pitch footprint for A2530 programming/debugging using a CC Debugger.

*Table 20 – J4 A2530 Program/Debug Connector Pinout*

Pin	Signal Name	I/O	Description
J3-1	GND	-	Ground reference
J3-2	VDD	O	Supply voltage to debugger
J3-3	MODULE_DC	I	Radio Module Debug Clock
J3-4	MODULE_DD	I/O	Radio Module Debug Data
J3-5	-	-	
J3-6	-	-	
J3-7	MRST	I	Radio Module Hardware Reset – active low
J3-8	-	-	
J3-9	-	-	
J3-10	-	-	

- **J5 – Radio Module GPIO Interface**  
0.1” pitch thru-hole footprint which provides access to the Radio Module’s four GPIO signals. For applications requiring use of these pins, the LEDs and 2KΩ pull-down resistors sharing the GPIO signals may be electrically isolated by turning off the S4 DIP switches (see Table 5 for more info regarding the DIP switches).

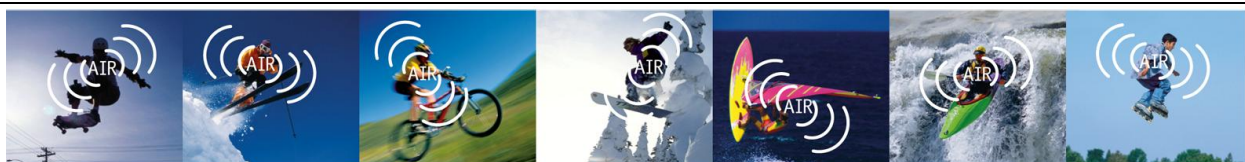
*Table 21 – J5 A2530 GPIO Connector Pinout*

Pin	Signal Name	I/O	Description
J3-1	GND	-	Ground reference
J3-2	VDD	O	Supply voltage
J3-3	GPIO1	I/O	Radio Module P0.1
J3-4	GPIO0	I/O	Radio Module P0.0
J3-5	GPIO3	I/O	Radio Module P1.0
J3-6	GPIO2	I/O	Radio Module P0.6

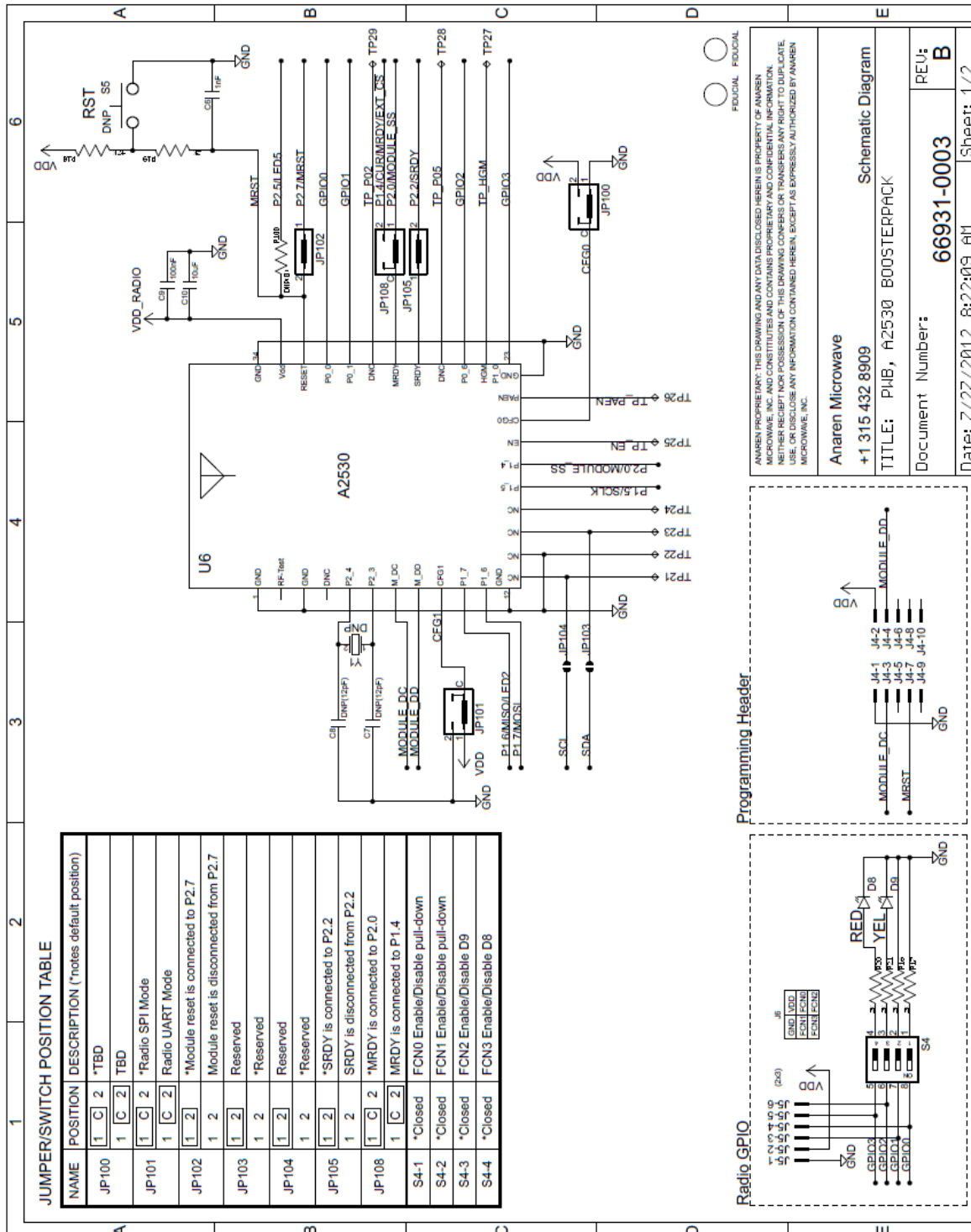
- **J101 – External Power Interface**  
2mm pitch shrouded header for connecting external power (e.g. from a battery) to the BoosterPack. The positive terminal has a series Schottky diode to prevent accidental battery charging in the event the BoosterPack is installed on a powered LaunchPad.

*Table 22 – J101 External Power (Battery) Connector Pinout*

Pin	Signal Name	I/O	Description
J101-1	GND	-	Ground reference
J101-2	VDD	I	Supply voltage



### 3.3. Schematics



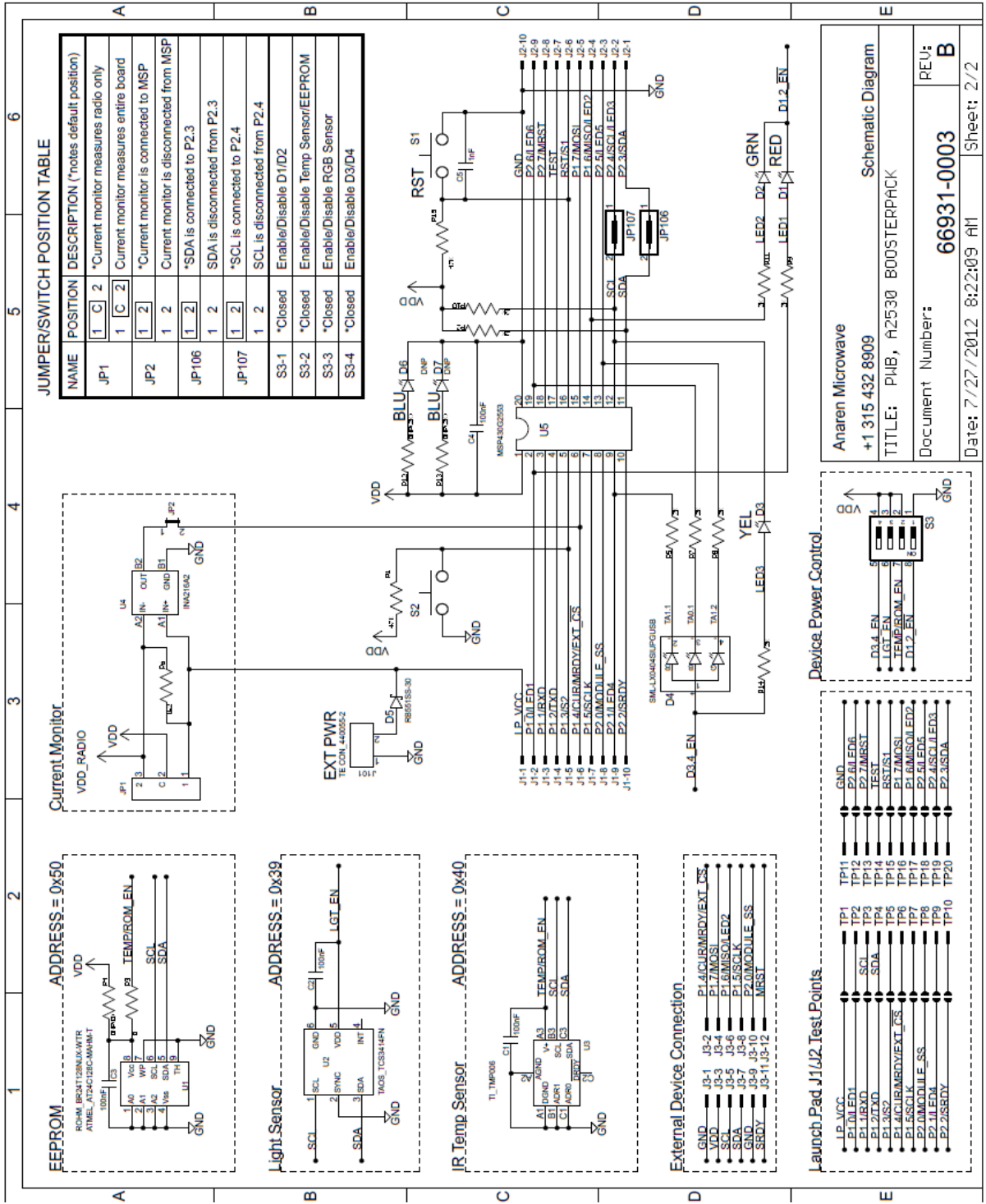
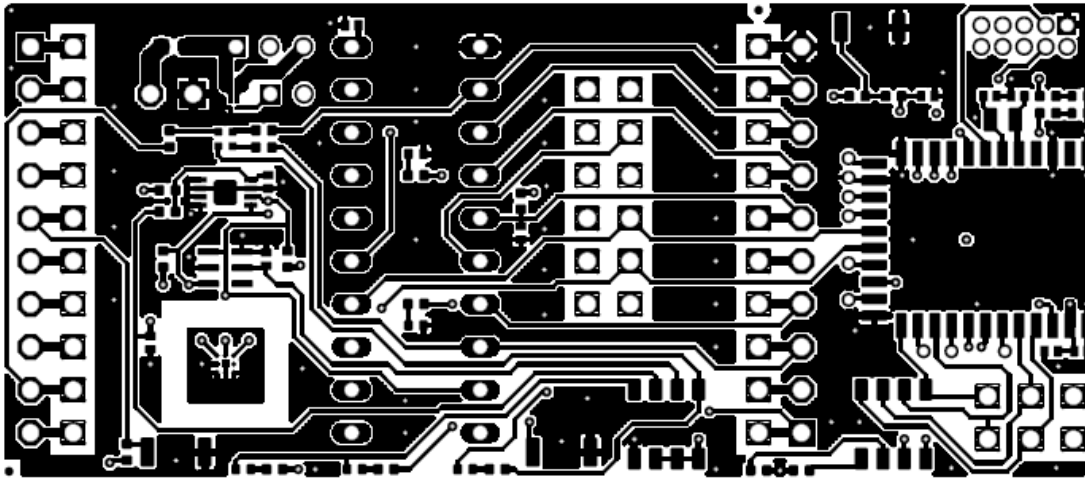


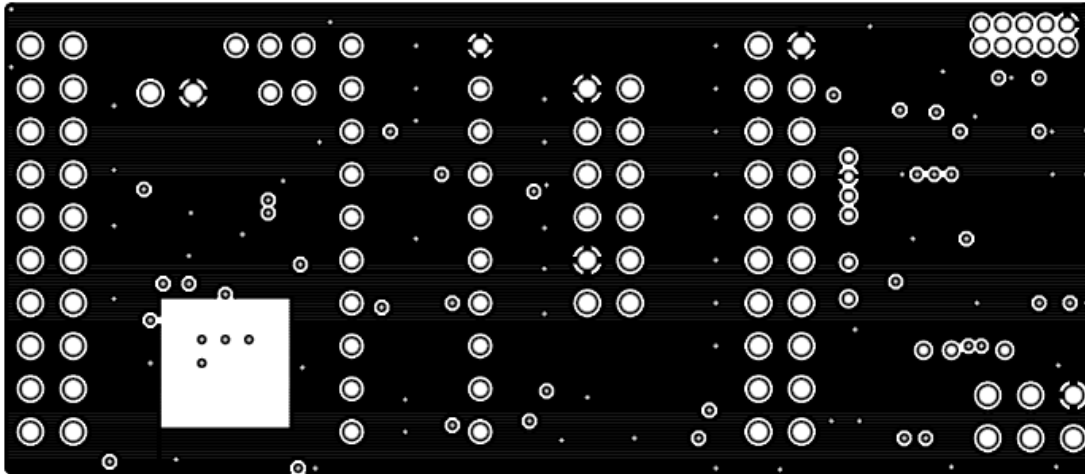
Figure 14 - Schematic Sheet 2



### 3.4. PCB Layout

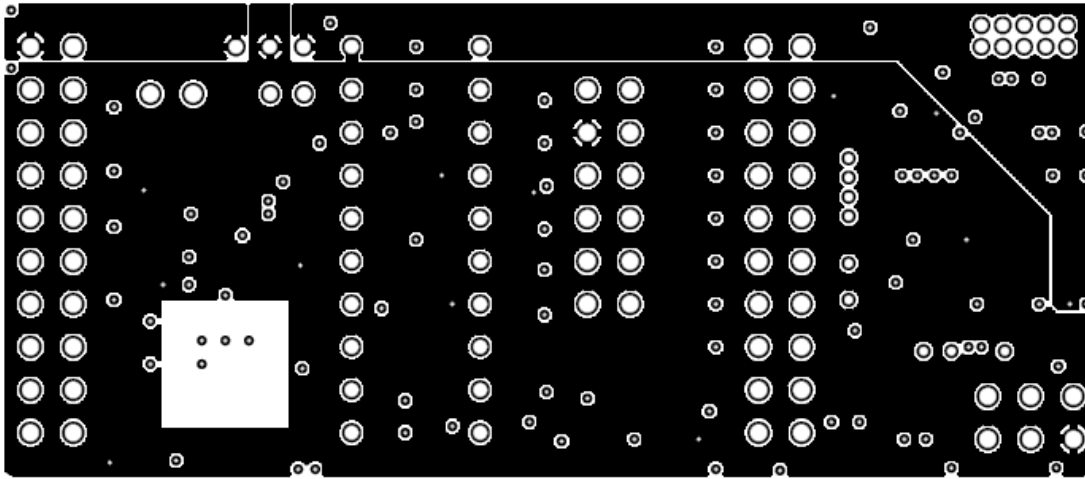


*Figure 15 - PCB Layout Top Layer*

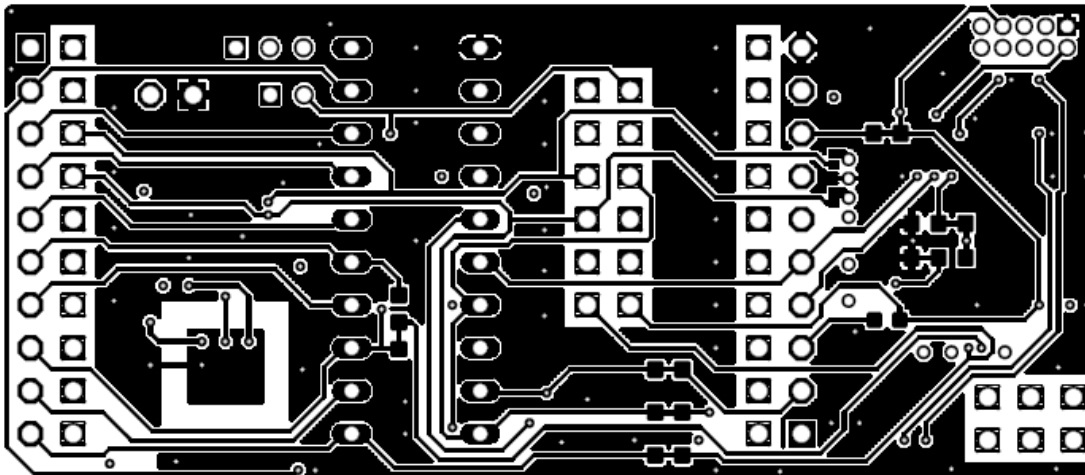


*Figure 16 - PCB Layout Inner Layer (GND Plane)*





*Figure 17 - PCB Layout Inner Layer (Split PWR Plane)*



*Figure 18 - PCB Layout Bottom Layer*



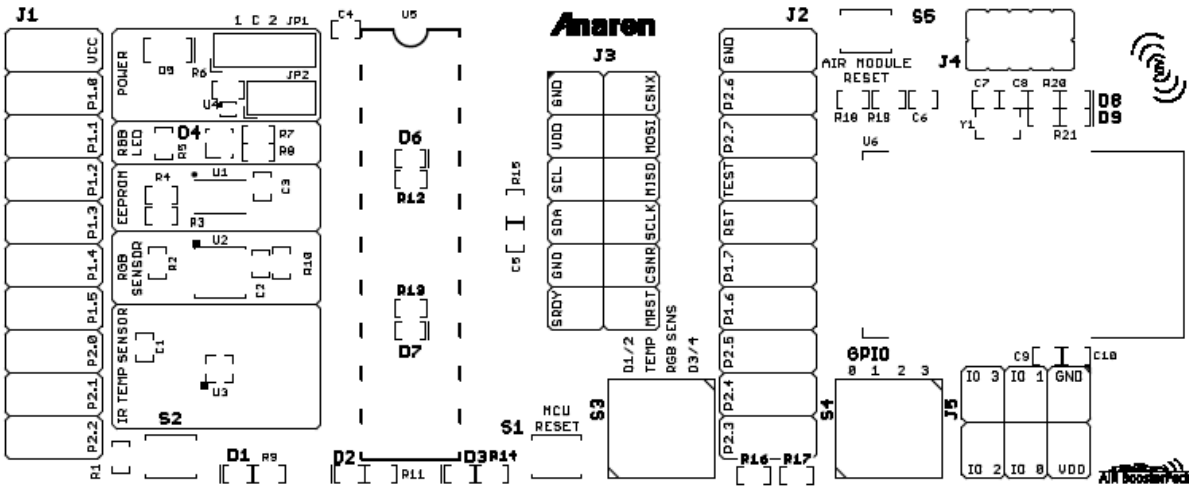


Figure 19 - PCB Layout Top Silkscreen

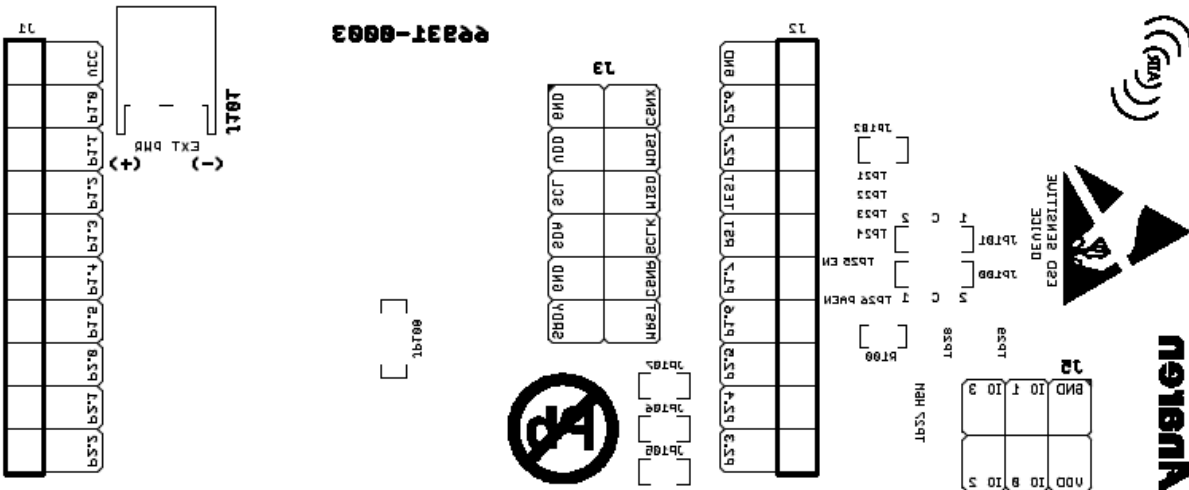


Figure 20 - PCB Layout Bottom Silkscreen



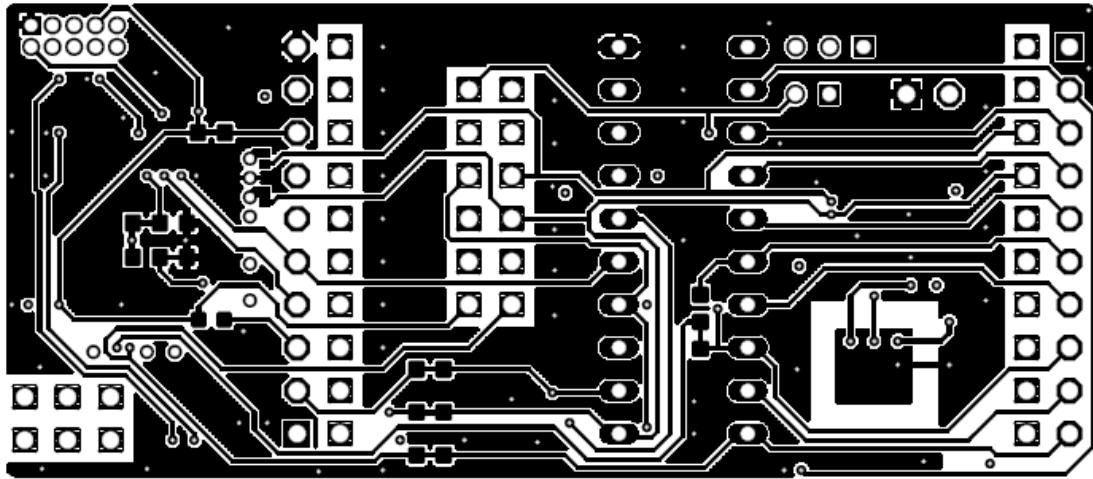


Figure 21 - PCB Layout Bottom Layer Mirror Image

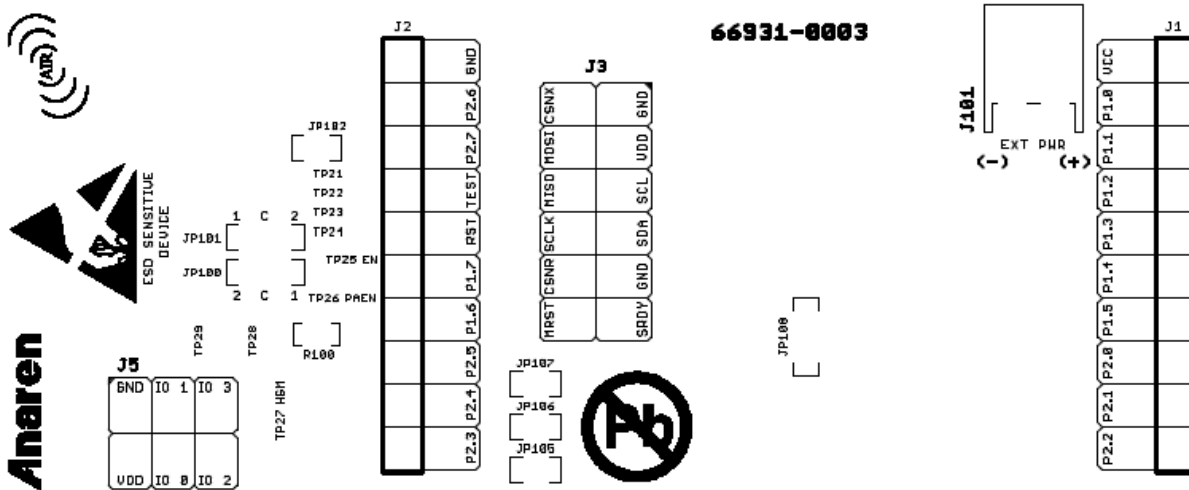


Figure 22 - PCB Layout Bottom Silkscreen Mirror Image





### 3.5. Bill of Materials (BOM)

Table 23 - Bill of Material

Item	Ref Des	Qty	Description	Comment
1	C1,C2,C3, C4,C9	5	CAP CER 0.1UF 16V 10% X7R 0402	
2	C5,C6	2	CAP CER 1000PF 50V 5% NP0 0402	
3	C7,C8	2 NP	CAP CER 12PF 50V 5% NP0 0402	Not populated
4	C10	1	CAP CER 10UF 6.3V 20% X5R 0603	
5	D1,D8	2	LED 0402 RED SMD	
6	D2	1	LED 0402 GREEN SMD	
7	D3,D9	2	LED 0402 YELLOW SMD	
8	D4	1	LED RGB SQUARE CLEAR SMD	
9	D5	1	DIODE SCHOTTKY 500mA SMD	
10	D6,D7	2 NP	LED 0402 BLUE SMD	Not populated  Kingbright APHHS1005QBC/D (or equivalent)
11	J1,J2	2	CONN SOCKET 10POS 2.54MM SINGLE ROW VERTICAL T/H	
12	J3	1 NP	CONN HEADER 12POS 2.54MM DUAL ROW VERTICAL T/H	Not populated
13	J4	1 NP	CONN HEADER 10POS 1.27MM DUAL ROW VERTICAL T/H SHROUDED	Not populated  Samtec SHF-105-01-L-D-TH (or equivalent)
14	J5	1 NP	CONN HEADER 6POS 2.54MM DUAL ROW VERTICAL T/H	Not populated
15	J101	1	CONN HEADER 2POS 2MM RA T/H	
16	JP1 (HDR)	1	CONN HEADER 3POS 2MM SINGLE ROW VERTICAL T/H	
17	JP1 (SHUNT)	1	CONN SHUNT 2MM 2POS GOLD	
18	JP2 (HDR)	1	CONN HEADER 2POS 2MM SINGLE ROW VERTICAL T/H	
19	JP2 (SHUNT)	1	CONN SHUNT 2MM 2POS GOLD	
20	JP100, JP101, JP108	3 NP	JUMPER 3PAD SMD (RES 0.0 OHM 1/10W 0603 SMD)	Not populated
21	JP102, JP105, JP106, JP107	4 NP	JUMPER 2PAD SMD (RES 0.0 OHM 1/10W 0603 SMD)	Not populated



Item	Ref Des	Qty	Description	Comment
22	R1,R15, R18	3	RES 47K OHM 1/10W 5% 0402 SMD	
23	R2,R5,R7, R8,R9, R10,R11, R12,R13, R14,R16, R17,R19, R20,R21	13/2 NP	RES 2K OHM 1/10W 5% 0402 SMD	R12,R13 not populated
24	R3,R6	2	RES 0.2 OHM 1/10W 1% 0603 SMD	
25	R4	1 NP	RES 0.0 OHM 1/10W 0402 SMD	Not populated
26	R100	1 NP	RES 0.0 OHM 1/10W 0603 SMD	Not populated
27	S1,S2,S5	2/1 NP	SWITCH TACT SPST NO SMD	S5 not populated  Omron B3U-1000P (or equivalent)
28	S3,S4	2	SWITCH DIP 4POS 1.27MM SMD	
29	U1	1	IC EEPROM 128KBIT 400KHZ 8UDFN	Atmel AT24C128C-MAHM-T
30	U2	1	IC COLOR SENSOR DGTL PROGR 6-DFN	TAOS TCS3414FN
31	U3	1	IC SENSOR THERMOPILE 8DSBGA	Texas Instruments TMP006AIYZFT
32	U4	1	IC CURRENT SHUNT MONITOR 4DSBGA	Texas Instruments INA216A2YFFR
33	U5 (SKT)	1	IC SOCKET 20PIN	
34	U5 (IC)	1	IC MCU 16BIT 16KB FLASH 20PDIP	Texas Instruments MSP430G2553IN20
35	U6	1	RADIO MODULE A2530 SMD	Anaren A2530E24AZ1 or A2530R24AZ1 Not populated
36	Y1	1 NP	CRYSTAL 32.768 KHZ 12.5PF SMD	Abrakon ABS06-32.768KHZ-T (or equivalent)



## HISTORY

Date	Author	Change Note No./Notes
11/2/12		Initial Draft

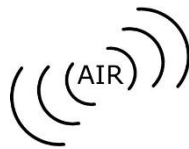


**THIS PAGE LEFT INTENTIONALLY BLANK**

Attach distributor contact information  
here

If you have additional questions, need samples, or would like a quote –  
please email the AIR team at [AIR@anaren.com](mailto:AIR@anaren.com) .

For a full list of our franchised distributors, please visit our website:  
<http://www.anaren.com/air/>



---

**Anaren Microwave, Inc.**  
6635 Kirkville Road  
East Syracuse, NY 13057  
Tel: +1 315 432 8909  
+1 800 411 6596  
Fax: +1 315 432 8970

**Anaren Microwave (Europe), Inc.**  
12 Somerset House, Suite 16 & 17  
Hussar Court, Waterlooville  
Hampshire, England P07-7SG  
Tel: +44 2392 232392  
Fax: +44 2392 251369

**Anaren Communication Suzhou Co. Ltd.**  
No. 5 Chun Hui Road  
Wei Ting, Suzhou Industrial Park  
Suzhou 215122, PR China  
Tel: +86 512 6287 6400  
Fax: +86 512 6274 9283

---