

Multimeter with IR Thermometer

Extech EX210 and EX210T (True RMS)

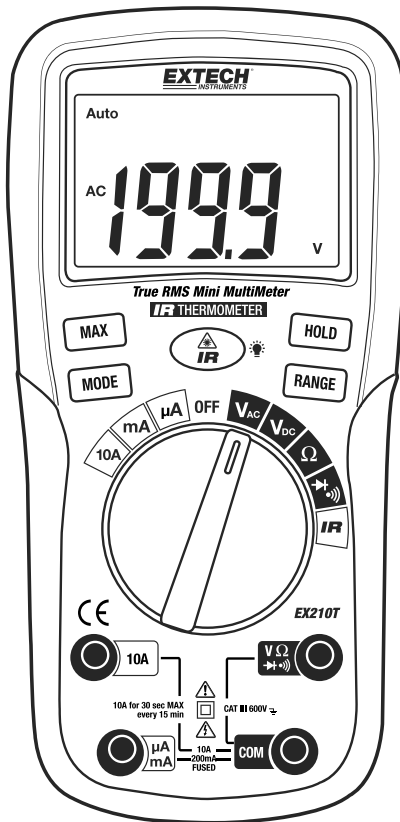

Introduction

Thank you for selecting the Extech EX210/EX210T True RMS (EX210T only) Autoranging Multimeter. This meter measures AC/DC Voltage, AC/DC Current, Resistance, Diode Test, and Continuity plus non-contact InfraRed Temperature. Proper use and care of this meter will provide many years of reliable service. Please visit the Extech Instruments website (www.extech.com) to check for the latest version of this User Guide. Extech Instruments is an ISO-9001 certified company.

Safety



This symbol adjacent to another symbol, terminal or operating device indicates that the operator must refer to an explanation in the Operating Instructions to avoid personal injury or damage to the meter.

WARNING

This **WARNING** symbol indicates a potentially hazardous situation, which if not avoided, could result in death or serious injury.

CAUTION

This **CAUTION** symbol indicates a potentially hazardous situation, which if not avoided, may result damage to the product.



This symbol advises the user that the terminal(s) so marked must not be connected to a circuit point at which the voltage with respect to earth ground exceeds (in this case) 600 VAC or VDC.



This symbol adjacent to one or more terminals identifies them as being associated with ranges that may, in normal use, be subjected to particularly hazardous voltages. For maximum safety, the meter and its test leads should not be handled when these terminals are energized.



This symbol indicates that a device is protected throughout by double insulation or reinforced insulation.

PER IEC1010 OVERVOLTAGE INSTALLATION CATEGORY

OVERVOLTAGE CATEGORY I

Equipment of OVERVOLTAGE CATEGORY I is equipment for connection to circuits in which measures are taken to limit the transient overvoltages to an appropriate low level.

Note – Examples include protected electronic circuits.

OVERVOLTAGE CATEGORY II

Equipment of OVERVOLTAGE CATEGORY II is energy-consuming equipment to be supplied from the fixed installation.

Note – Examples include household, office, and laboratory appliances.

OVERVOLTAGE CATEGORY III

Equipment of OVERVOLTAGE CATEGORY III is equipment in fixed installations.

Note – Examples include switches in the fixed installation and some equipment for industrial use with permanent connection to the fixed installation.

OVERVOLTAGE CATEGORY IV

Equipment of OVERVOLTAGE CATEGORY IV is for use at the origin of the installation.

Note – Examples include electricity meters and primary over-current protection equipment

CAUTIONS

- Improper use of this meter can cause damage, shock, injury or death. Read and understand this user manual before operating the meter.
- Always remove the test leads before replacing the battery or fuses.
- Inspect the condition of the test leads and the meter itself for any damage before operating the meter.
- Use great care when making measurements if the voltages are greater than 25 VAC rms or 35 VDC. These voltages are considered a shock hazard.
- Warning! This is a Class A device. This device can cause interference in residential areas.
- Always discharge capacitors and remove power from the device under test before performing Diode, Resistance or Continuity tests.
- Voltage checks on electrical outlets can be difficult and misleading because of the uncertainty of connection to the recessed electrical contacts. Other means should be used to ensure that the terminals are not "live".
- If the equipment is used in a manner not specified by the manufacturer, the protection provided by the equipment may be impaired.
- This device must not be used by children. It contains hazardous objects as well as small parts that the children could swallow.
- Do not leave batteries and packing material lying around unattended; they can be dangerous to children.
- In the event that this device will be stored for an extended period of time, remove the batteries.
- Expired or damaged batteries can leak and can be hazardous to skin. Use suitable hand gloves in such cases.
- Do not short-circuit the battery. Do not place the battery near a fire.
- Never mix battery types. Always install new batteries of the same type.

SAFETY INSTRUCTIONS

This meter has been designed for safe use, but must be operated with caution. The rules listed below must be carefully followed for safe operation.

1. **NEVER** apply voltage or current to the meter that exceeds the specified maximum:

Input Protection Limits	
Function	Maximum Input
V AC/DC, Resistance, Diode Test, Continuity	600 VDC/AC rms
μ A or mA AC/DC	200mA fused
A AC/DC	10A fused

2. **USE EXTREME CAUTION** when working with high voltages.
3. **DO NOT** measure voltage if the voltage on the "COM" input jack exceeds 600V above earth ground.
4. **NEVER** connect the meter leads across a voltage source while the function switch is in the current, resistance, or diode mode. Doing so can damage the meter.
5. **ALWAYS** discharge filter capacitors in power supplies and disconnect the power when making resistance or diode tests.
6. **ALWAYS** turn off the power and disconnect the test leads before opening the covers to replace the fuse or batteries.
7. **NEVER** operate the meter unless the back cover and the battery and fuse covers are in place and fastened securely.
8. If the equipment is used in a manner not specified by the manufacturer, the protection provided by the equipment may be impaired.

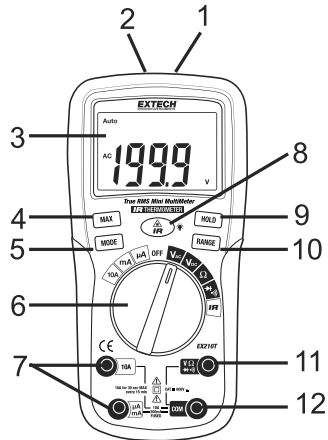

Controls and Jacks

1. IR Thermometer
2. Laser Pointer
3. 2000 count LCD
4. MAX button
5. MODE button
6. FUNCTION switch
7. mA, μ A and 10A input jacks
8. IR Thermometer button
9. HOLD button
10. RANGE button
11. Positive input jack
12. COM input jack



Note: Tilt stand, test lead holders, and battery compartment are on rear of unit.

Symbols and Enunciators

	Continuity
	Diode test
μ	micro (10^{-6}) (amps)
m	milli (10^{-3}) (volts, amps)
A	Amps
k	kilo (10^3) (ohms)
M	mega (10^6) (ohms)
Ω	Ohms
V	Volts
AC	Alternating current
DC	Direct current
$^{\circ}$ F	Degrees Fahrenheit
$^{\circ}$ C	Degrees Centigrade
MAX	Maximum
AUTO	Autoranging
HOLD	Display hold
SCAN	IR temperature in progress

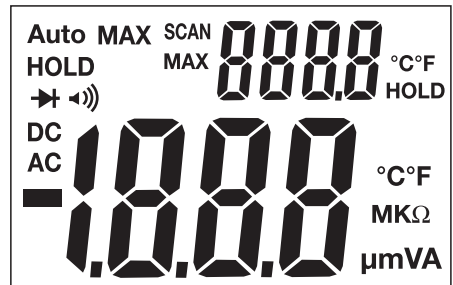

Operating Instructions

WARNING: Risk of electrocution. High-voltage circuits, both AC and DC, are extremely dangerous and should be measured with great care.

1. ALWAYS turn the function switch to the **OFF** position when the meter is not in use.
2. If “OL” appears in the display during a measurement, the value exceeds the range you have selected. Change to a higher range.

AC/DC VOLTAGE MEASUREMENTS

CAUTION: Do not measure DC voltages if a motor on the circuit is being switched ON or OFF. Large voltage surges may occur that can damage the meter.

1. Rotate the function switch to the **VAC** or **VDC** position.
2. Insert the black test lead banana plug into the negative **COM** jack. Insert the red test lead banana plug into the positive **V** jack.
3. Touch the black test probe tip to the negative side of the circuit.
Touch the red test probe tip to the positive side of the circuit.
4. Read the voltage in the display.

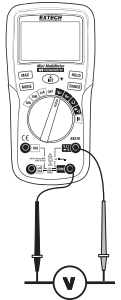

AC/DC CURRENT MEASUREMENTS

1. Insert the black test lead banana plug into the negative **COM** jack.
2. Press the **MODE** button to indicate “**DC**” or “**AC**” on the display.
3. For current measurements up to 2000 μ A, set the function switch to the **μ A** position and insert the red test lead banana plug into the **μ A/mA** jack.
4. For current measurements up to 200 mA DC, set the function switch to the **mA** position and insert the red test lead banana plug into the **μ A/mA** jack.
5. For current measurements up to 10A DC, set the function switch to the **10A** position and insert the red test lead banana plug into the **10A** jack.
6. Connect the test leads in series with the circuit under test.
7. Apply power to the circuit.
8. Read the current in the display.

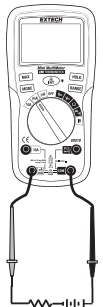

RESISTANCE MEASUREMENTS

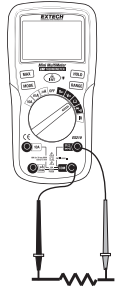

WARNING: To avoid electric shock, disconnect power to the unit under test and discharge all capacitors before taking any resistance measurements. Remove the batteries and unplug the line cords.

1. Rotate the function switch to the Ω position.
2. Insert the black test lead banana plug into the negative **COM** jack. Insert the red test lead banana plug into the positive Ω jack.
3. Touch the test probe tips across the device under test.
4. Read the resistance in the display.





CONTINUITY CHECK

WARNING: To avoid electric shock, never measure continuity on circuits or wires that have a voltage potential.

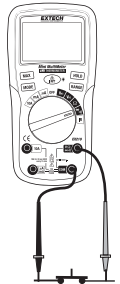
1. Rotate the function switch to the  position.
2. Insert the black lead banana plug into the negative **COM** jack. Insert the red test lead banana plug into the positive  jack.
3. Press the **MODE** button to indicate "" on the display.
4. Touch the test probe tips to the circuit or wire you wish to check.
5. If the resistance is less than the continuity threshold, the audible signal will sound.



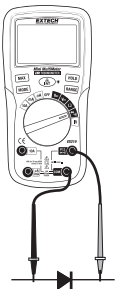

DIODE TEST

1. Rotate the function switch to the green  position.
2. Insert the black test lead banana plug into the negative **COM** jack and the red test lead banana plug into the positive  jack.
3. Press the **MODE** button to indicate "" and "**V**" on the display.
4. Touch the test probes to the diode under test. Forward voltage will typically indicate 0.400 to 0.700V. Reverse voltage will indicate "**OL**". Shorted devices will indicate near 0V and an open device will indicate "**OL**" in both polarities.



NON-CONTACT INFRARED TEMPERATURE MEASUREMENTS

1. Rotate the function switch to the **IR** position. The upper right four digit temperature display will switch on.
2. Press the **MODE** button to select °F or °C.
3. Aim the infrared sensor (top of meter) at the surface to be measured.
4. Press and Hold the **IRT**  button to turn on the IR thermometer and laser pointer. The laser pointer identifies the surface spot to be measured and "SCAN" will flash in the display.
5. Read the temperature in the display.
6. The area of the surface to be measured must be larger than the spot size as determined by the distance to spot size values listed in the specification table.
7. Release the **IRT**  button to turn the IR thermometer and laser pointer off. "HOLD" and the final measured value will remain in the display.

WARNING: Do not directly view or direct the laser pointer at an eye. Low power visible lasers do not normally present a hazard, but may present some potential for hazard if viewed directly for extended periods of time.

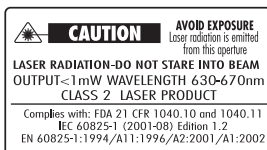

IR Spot to Distance Diagram

The 4:1 spot to distance ratio determines the size of the measured surface area with respect to the distance the meter is held away from the surface.

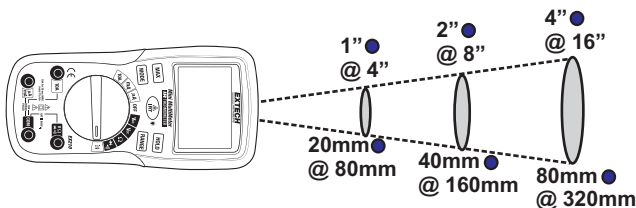

IR Measurement Notes

1. The object under test should be larger than the spot (target) size calculated by the field of view diagram.
2. If the surface of the object under test is covered with frost, oil, grime, etc., clean before taking measurements.
3. If an object's surface is highly reflective, apply masking tape or flat black paint to the surface before measuring.
4. The meter will not make measurements through glass steam, dust, and smoke.
5. To find a hot spot, aim the meter outside the area of interest then scan across (in an up and down motion) until the hot spot is located.

AUTORANGING/MANUAL RANGE SELECTION

When the meter is first switched on, it automatically enters the AutoRanging mode. This automatically selects the best range for the measurements being made and is generally the best mode for most measurements. For measurement situations requiring that a range be manually selected, perform the following:

1. Press the **RANGE** button. The “**AUTO**” display indicator will turn off.
2. Press the **RANGE** key to step through the available ranges until the range desired is selected.
3. Press and hold the **RANGE** button for 2 seconds to exit manual ranging.



Note: Manual ranging does not apply to the Temperature, Diode and Continuity functions.

MAX (MAXIMUM READING) MODE

1. Press the **MAX** button to activate the MAX mode. The display icon “**MAX**” will appear. The meter will display and hold the maximum reading and will update only when a new maximum value is detected.
2. Press the **MAX** button again to exit the mode.

Note: Max does not apply to the Resistance, Diode and Continuity functions.

DISPLAY BACKLIGHT

Press and hold the IRT   button for 2 second to turn the backlight on. The backlight will automatically turn off after approximately 10 seconds or press and hold the button again for 2 seconds to manually turn it off.

HOLD

The **HOLD** function freezes the reading in the display. Press the **HOLD** button momentarily to activate or to exit the **HOLD** function.

Note: The HOLD button does not function in the IR measurement mode.

AUTO SLEEP

If no button is pressed the auto sleep feature will place the meter in sleep mode after approximately 15 minutes of operation. If this happens, press any button to wake the meter or switch the meter to OFF if it no longer in use.

Maintenance

WARNING: To avoid electric shock, disconnect the test leads from any source of voltage before removing the back cover or the battery or fuse covers.

WARNING: To avoid electric shock, do not operate the meter until the battery and fuse covers are in place and fastened securely.

This MultiMeter is designed to provide years of dependable service, if the following care instructions are followed:

1. **KEEP THE METER DRY.** If it gets wet, wipe it off.
2. **USE AND STORE THE METER IN NORMAL TEMPERATURES.** Temperature extremes can shorten the life of the electronic parts and distort or melt plastic parts.
3. **HANDLE THE METER GENTLY AND CAREFULLY.** Dropping it can damage the electronic parts or the case.
4. **KEEP THE METER CLEAN.** Wipe the case occasionally with a damp cloth. DO NOT use chemicals, cleaning solvents, or detergents.
5. **USE ONLY FRESH BATTERIES OF THE RECOMMENDED SIZE AND TYPE.** Remove old or weak batteries so they do not leak and damage the unit.
6. **IF THE METER IS TO BE STORED FOR A LONG PERIOD OF TIME,** the batteries should be removed to prevent damage to the unit.

BATTERY and FUSE Replacement

WARNING: To avoid electric shock, disconnect the test leads from any source of voltage before removing the battery cover.

1. Turn power off and disconnect the test leads from the meter.
2. Lift the meter stand to expose the battery cover.
3. Open the rear battery/fuse compartment by removing the Phillips head screw on the lower rear of the meter.
4. Carefully pull down on the cover just enough to release the latch and then lift it off. The cover will not pull down all the way.
5. Remove the old battery or fuse and install a new one of the correct rating.
6. Place the battery/fuse cover back in place. Secure with the screw.

WARNING: To avoid electric shock, do not operate the meter until the battery cover is in place and fastened securely.

NOTE: If the meter does not work properly, check the fuses and replace the battery to make sure that they are still good and that they are properly inserted.

Battery Safety Reminders

- Please dispose of batteries responsibly; observe local, state, and national regulations.
- Never dispose of batteries in a fire; batteries may explode or leak.
- Never mix battery types; install new batteries of the same type.

Specifications

Function	Range	Resolution	Accuracy	
DC Voltage	200 mV	0.1 mV	±(0.8% reading + 6 digits)	
	2V	0.001V	±(0.5% reading + 2 digits)	
	20V	0.01V		
	200V	0.1V	±(0.8% reading + 2 digits)	
	600V	1V		
AC Voltage (50/60Hz)	200 mV	0.1 mV	±(1.5% reading + 6 digits)	
	2V	0.001V		
	20V	0.01V		
	True RMS (EX210T only)	200V		0.1V
		600V		1V
All AC voltage ranges are specified from 5% of range to 100% of range				
DC Current	200 µA	0.1 µA	±(1.5% reading + 5 digits)	
	2000 µA	1 µA		
	20 mA	0.01 mA		
	200 mA	0.1 mA		
	2.000	0.001 A	±(2.5% reading + 5 digits)	
	10 A	0.01 A		
	Note: 10A for 30 sec max			
AC Current (50/60Hz)	200 µA	0.1 µA	±(1.5% reading + 8 digits)	
	2000 µA	1 µA		
	20 mA	0.01 mA		
	True RMS (EX210T only)	200 mA	0.1 mA	±(3.0% reading + 5 digits)
		2.000	0.001 A	
10 A	0.01 A			
Note: 10A for 30 sec max				

NOTE: Accuracy is stated at 18°C to 28°C (65°F to 83°F) and less than 75% RH.

Function	Range	Resolution	Accuracy
Resistance	200 Ω	0.1 Ω	±(0.8% reading + 5 digits)
	2 kΩ	0.001 kΩ	±(0.8% reading + 2 digits)
	20 kΩ	0.01 kΩ	
	200 kΩ	0.1 kΩ	
	2 MΩ	0.001 MΩ	±(2.5% reading + 8 digits)
	20 MΩ	0.01 MΩ	
Temperature IR	-20 to 0°C	0.1°C/°F	±4°C
	0 to 93°C		±(2.0%rdg or 2°C)
	93 to 230°C		±(3.0%rdg or 3°C)
	-5 to 32°F		± 8°F
	32 to 200°F		±(2.0%rdg or 4°F)
	200 to 446°F		±(3.0%rdg or 6°F)

Enclosure	Double molded
Diode Test	Test current of 0.9mA maximum, open circuit voltage 2.8V DC typical
Continuity	Threshold 20 to 50Ω, test current <1.5mA
Input Impedance	10MΩ VDC/VAC
AC Response	True rms (EX210T only)
ACV Bandwidth	40Hz to 1000Hz
IR Spectral response	6 to 16μm
IR Emissivity	0.95 fixed
IR distance ratio	4:1
Laser pointer	Class 2 laser < 1mW power; Wavelength is 630 to 670nm
Display	2,000 count backlit liquid crystal display
Overrange indication	"OL" is displayed
Auto Power Off	15 minutes (approximately)
Polarity	Automatic (no indication for positive); Minus (-) sign for negative
Measurement Rate	2 times per second, nominal
Battery	One 9 volt (NEDA 1604) battery
Fuses	mA, μA ranges; 200mA 250V ceramic fast blow 'A' range; 10A 600V ceramic fast blow
Operating Temperature	14°F to 122°F (-10°C to 40°C)
Storage Temperature	14°F to 140°F (-10°C to 60°C)
Operating Humidity	Max 80% up to 31°C (87°F) decreasing linearly to 50% at 40°C (104°F)
Storage Humidity	<80%
Operating Altitude	7000 ft (2000m) maximum
Weight	9.17 oz. (260 g)
Size	5.8x2.9x1.6" (147x76x42 mm)
Safety	This meter is intended for origin of installation use and protected, against the users, by double insulation per IEC/EN 61010-1:2001 and IEC/EN 61010-031:2002 to Category III 600V; Pollution Degree 2.
Approvals	CE

Warranty

FLIR Systems, Inc. warrants this Extech Instruments brand device to be free of defects in parts and workmanship for one year from date of shipment (a six month limited warranty applies to sensors and cables). If it should become necessary to return the instrument for service during or beyond the warranty period, contact the Customer Service Department for authorization. Visit the website www.extech.com for contact information. A Return Authorization (RA) number must be issued before any product is returned. The sender is responsible for shipping charges, freight, insurance and proper packaging to prevent damage in transit. This warranty does not apply to defects resulting from action of the user such as misuse, improper wiring, operation outside of specification, improper maintenance or repair, or unauthorized modification. FLIR Systems, Inc. specifically disclaims any implied warranties or merchantability or fitness for a specific purpose and will not be liable for any direct, indirect, incidental or consequential damages. FLIR's total liability is limited to repair or replacement of the product. The warranty set forth above is inclusive and no other warranty, whether written or oral, is expressed or implied.

Calibration, Repair, and Customer Care Services

FLIR Systems, Inc. offers repair and calibration services for the Extech Instruments products we sell. NIST certification for most products is also provided. Call the Customer Service Department for information on calibration services available for this product. Annual calibrations should be performed to verify meter performance and accuracy. Technical support and general customer service is also provided, refer to the contact information provided below.

Support Lines: U.S. (877) 439-8324; International: +1 (603) 324-7800

Technical Support: Option 3; E-mail: support@extech.com

Repair & Returns: Option 4; E-mail: repair@extech.com

Product specifications are subject to change without notice

Please visit our website for the most up-to-date information

www.extech.com

FLIR Commercial Systems, Inc., 9 Townsend West, Nashua, NH 03063 USA

ISO 9001 Certified

Copyright © 2013-2015 FLIR Systems, Inc.

All rights reserved including the right of reproduction in whole or in part in any form

www.extech.com

Garantie

FLIR Systems, Inc. garantit que cet appareil Extech Instruments est exempt de défauts matériaux et de fabrication pendant un an à partir de la date d'envoi (une garantie limitée de six mois s'applique aux capteurs et aux câbles). Si le renvoi de l'appareil pour réparation devient nécessaire durant ou après la période de garantie, contactez le service client pour autorisation. Pour obtenir les coordonnées, visitez le site Web suivant : www.extech.com. Un numéro d'autorisation de retour (AR) doit être délivré avant tout retour de produit. L'expéditeur prend à sa charge les frais d'expédition, le fret, l'assurance et l'emballage correct de l'appareil afin de prévenir toute détérioration durant le transport. Cette garantie ne s'applique pas aux dommages imputables à l'utilisateur, tels que l'usage impropre ou abusif, un mauvais câblage, une utilisation non conforme aux spécifications, un entretien ou une réparation incorrecte, ou toute modification non autorisée. FLIR Systems, Inc. déclinera spécifiquement toute garantie ou qualité marchande ou aptitude à l'emploi prévu, et ne sera en aucun cas tenu responsable pour tout dommage consécutif, direct, indirect ou accidentel. La responsabilité totale de FLIR est limitée à la réparation ou au remplacement du produit. La garantie définie ci-dessus est inclusive et aucune autre garantie, écrite ou orale, n'est exprimée ou implicite.

Calibrage, réparation et services après-vente

FLIR Systems, Inc. offre des services de calibrage et de réparation pour les produits Extech Instruments que nous commercialisons. Nous fournissons également une certification NIST pour la plupart des produits. Contactez notre service client pour toute information sur les services de calibrage disponibles pour ce produit. Un calibrage doit être effectué chaque année pour vérifier les performances et la précision du mètre. Nous offrons également une assistance technique et un service à la clientèle. Veuillez vous reporter aux coordonnées fournies ci-dessous.

Lignes d'assistance: États-Unis (877) 439-8324; international: +1 (603) 324-7800

Service d'assistance technique : Option 3 ; E-mail : support@extech.com

Réparations et retours : Option 4 ; E-mail : repair@extech.com

Les spécifications produit sont sujettes à modifications sans préavis.

Pour les toutes dernières informations, veuillez visiter notre site Web.

www.extech.com

FLIR Commercial Systems, Inc., 9 Townsend West, Nashua, NH 03063 USA

Certifié ISO 9001

Copyright © 2013-2015 FLIR Systems, Inc.

Tous droits réservés, y compris la reproduction partielle ou totale sous quelque forme que ce soit.

www.extech.com

Garantía

FLIR Systems, Inc., garantiza este dispositivo marca Extech Instruments para estar libre de defectos en partes o mano de obra durante un año a partir de la fecha de embarque (se aplica una garantía limitada de seis meses para cables y sensores). Si fuera necesario regresar el instrumento para servicio durante o después del periodo de garantía, llame al Departamento de Servicio a Clientes para obtener autorización. Visite www.extech.com para Información de contacto. Se debe expedir un número de Autorización de Devolución (AD) antes de regresar cualquier producto. El remitente es responsable de los gastos de embarque, flete, seguro y empaque apropiado para prevenir daños en tránsito. Esta garantía no se aplica a defectos resultantes de las acciones del usuario como el mal uso, alambrado equivocado, operación fuera de las especificaciones, mantenimiento o reparación inadecuada o modificación no autorizada. FLIR Systems, Inc., rechaza específicamente cualesquier garantías implícitas o factibilidad de comercialización o idoneidad para cualquier propósito determinado y no será responsable por cualesquier daños directos, indirectos, incidentales o consecuentes. La responsabilidad total de FLIR está limitada a la reparación o reemplazo del producto. La garantía precedente es inclusiva y no hay otra garantía ya sea escrita u oral, expresa o implícita.

Servicios de calibración, reparación y atención a clientes

FLIR Systems, Inc., ofrece servicios de reparación y calibración para los productos que vendemos de Extech Instruments. Además ofrecemos certificación NIST para la mayoría de los productos. Llame al Departamento de Servicio al Cliente para solicitar información de calibración para este producto. Para verificar el funcionamiento y precisión se debe realizar la calibración anual. Además se provee Soporte Técnico y servicios generales al cliente, consulte la información de contacto en seguida.

Líneas de soporte: EE.UU. (877) 439-8324; Internacional: +1 (603) 324-7800

Soporte Técnico Opción 3; correo electrónico: support@extech.com

Reparación / Devoluciones: Opción 4; correo electrónico: repair@extech.com

Las especificaciones del producto están sujetas a cambios sin aviso

Por favor visite nuestra página en Internet para la información más actualizada

www.extech.com

FLIR Commercial Systems, Inc., 9 Townsend West, Nashua, NH 03063 USA

Certificado ISO 9001

Copyright © 2013-2015 FLIR Systems, Inc.

Reservados todos los derechos, incluyendo el derecho de reproducción total o parcial en cualquier medio

www.extech.com